

THS309x High-Voltage, Low-Distortion, Current-Feedback Operational Amplifiers

1 Features

- Low distortion:
 - 84-dBc HD2 at 10 MHz, $R_L = 1\text{ k}\Omega$
 - 99-dBc HD3 at 10 MHz, $R_L = 1\text{ k}\Omega$
- Low noise:
 - 15-pA/ $\sqrt{\text{Hz}}$ noninverting current noise
 - 14-pA/ $\sqrt{\text{Hz}}$ inverting current noise
 - 1.1-nV/ $\sqrt{\text{Hz}}$ voltage noise
- High slew rate: 6000 V/ μs ($G = 5$, $V_O = 20\text{ V}_{PP}$)
- Wide bandwidth: 305 MHz ($G = 2$, $R_L = 100\ \Omega$)
- High output current drive: $\pm 310\text{ mA}$
- Wide supply range: $\pm 5\text{ V}$ to $\pm 16\text{ V}$
- Power-down feature: THS3095 only

2 Applications

- [High-voltage arbitrary waveform generators](#)
- [Pin Driver](#)
- [Power-FET drivers](#)
- [Source measurement unit \(SMU\)](#)
- [High capacitive load piezo element drivers](#)

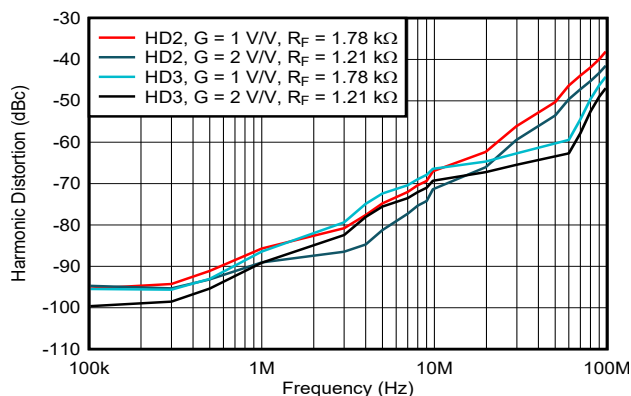

HD2 and HD3 vs Frequency at $R_L = 100\ \Omega$

3 Description

The THS3091 and THS3095 (THS309x) are high-voltage, low-distortion, high-speed, current-feedback amplifiers that operate over a wide supply range of $\pm 5\text{ V}$ to $\pm 16\text{ V}$. These devices are an excellent choice for applications that require large, linear output signals, such as pin drivers, power-FET drivers, and arbitrary waveform generators.

The THS3095 features a power-down pin ($\overline{\text{PD}}$) that puts the amplifier into a low-power standby mode, and lowers the quiescent current from 9.5 mA to 500 μA .

The wide, 32-V supply range, 6000-V/ μs slew-rate, and 310-mA output current drive make the THS309x an excellent choice for high-voltage arbitrary-waveform-driver applications. Moreover, with the ability to handle large voltage swings driving into low-resistance and high-capacitance loads while maintaining good settling time performance, these devices are an excellent choice for pin-driver and power-FET driver applications.

The THS309x are offered in an 8-pin SOIC (DDA) PowerPAD™ integrated circuit package. The THS3091 is also offered in an 8-pin HVSSOP (DGN) package.

Device Information⁽¹⁾⁽²⁾

PART NUMBER	$\overline{\text{PD}}$ PIN	PACKAGE
THS3091	No	DDA (SO PowerPAD, 8)
		DGN (HVSSOP, 8)
THS3095	Yes	DDA (SO PowerPAD, 8)

- (1) For all available packages, see the orderable addendum at the end of the data sheet.
- (2) For more information, see the [Device Comparison Table](#).

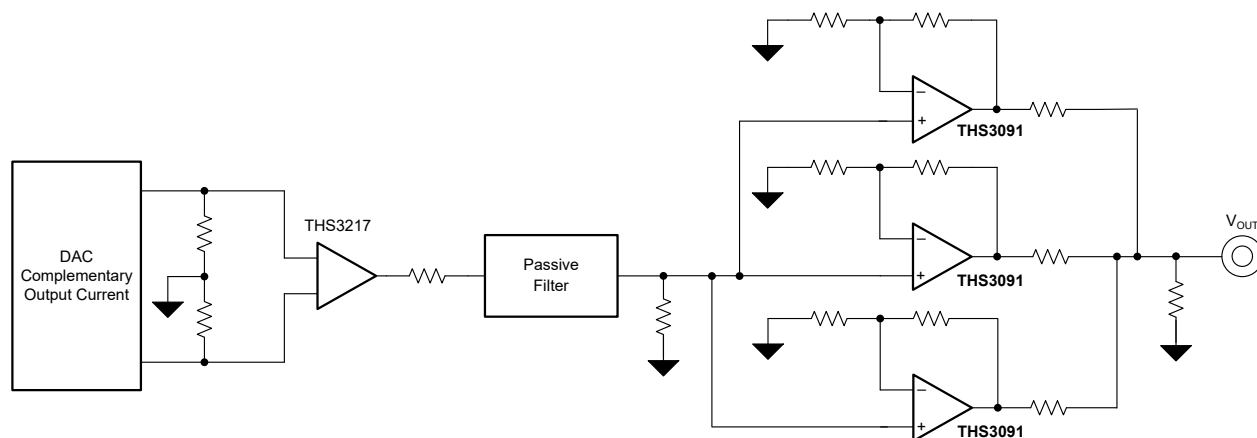

Typical Arbitrary Waveform Generator Output Drive Circuit



Table of Contents

1 Features	1	8.3 Feature Description.....	18
2 Applications	1	8.4 Device Functional Modes.....	20
3 Description	1	9 Application and Implementation	21
4 Revision History	2	9.1 Application Information.....	21
5 Device Comparison Table	4	9.2 Typical Application.....	21
6 Pin Configuration and Functions	4	9.3 Power Supply Recommendations.....	23
7 Specifications	5	9.4 Layout.....	24
7.1 Absolute Maximum Ratings.....	5	10 Device and Documentation Support	29
7.2 ESD Ratings.....	5	10.1 Device Support.....	29
7.3 Recommended Operating Conditions.....	5	10.2 Documentation Support.....	29
7.4 Thermal Information.....	5	10.3 Receiving Notification of Documentation Updates.....	29
7.5 Electrical Characteristics: $V_S = \pm 15\text{ V}$	6	10.4 Support Resources.....	29
7.6 Electrical Characteristics: $V_S = \pm 5\text{ V}$	8	10.5 Trademarks.....	29
7.7 Typical Characteristics: $\pm 15\text{ V}$	10	10.6 Electrostatic Discharge Caution.....	29
7.8 Typical Characteristics: $\pm 5\text{ V}$	16	10.7 Glossary.....	29
8 Detailed Description	18	11 Mechanical, Packaging, and Orderable Information	29
8.1 Overview.....	18		
8.2 Functional Block Diagram.....	18		

4 Revision History

NOTE: Page numbers for previous revisions may differ from page numbers in the current version.

Changes from Revision J (February 2023) to Revision K (April 2023)	Page
• Changed THS3091 DGN package status from preview to production data (active) and added associated content.....	1
• Changed voltage step from 10 V to 20 V for slew rate parameter in <i>Electrical Characteristics: $V_S = \pm 15\text{ V}$</i> table.....	6
• Added <i>Functional Block Diagram</i> section.....	18

Changes from Revision I (December 2022) to Revision J (February 2023)	Page
• Updated <i>Features</i> section.....	1
• Updated <i>Description</i> section.....	1
• Updated the <i>Device Comparison Table</i> section.....	4
• Removed D package information from the data sheet.....	4
• Removed continuous power dissipation specification from <i>Absolute Maximum Ratings</i> table.....	5
• Updated <i>ESD Ratings</i> table.....	5
• Updated <i>Thermal Information</i> table.....	5
• Changed <i>Electrical Characteristics THS3091</i> table to <i>Electrical Characteristics: $V_S = \pm 15\text{ V}$</i>	6
• Updated small signal bandwidth, -3 dB specifications in <i>Electrical Characteristics: $V_S = \pm 15\text{ V}$</i> and <i>Electrical Characteristics: $V_S = \pm 5\text{ V}$</i> tables.....	6
• Added small signal bandwidth, -3 dB specifications in <i>Electrical Characteristics: $V_S = \pm 15\text{ V}$</i> and <i>Electrical Characteristics: $V_S = \pm 5\text{ V}$</i> tables at $G=1$ for DGN package.....	6
• Removed slew rate (25% to 75% level) specifications from <i>Electrical Characteristics: $V_S = \pm 15\text{ V}$</i> and <i>Electrical Characteristics: $V_S = \pm 5\text{ V}$</i> tables.....	6
• Added slew rate (10% to 90% level) specifications to <i>Electrical Characteristics: $V_S = \pm 15\text{ V}$</i> and <i>Electrical Characteristics: $V_S = \pm 5\text{ V}$</i> tables.....	6
• Updated rise and fall time specifications in <i>Electrical Characteristics: $V_S = \pm 15\text{ V}$</i> and <i>Electrical Characteristics: $V_S = \pm 5\text{ V}$</i> tables.....	6
• Updated settling time specifications in <i>Electrical Characteristics: $V_S = \pm 15\text{ V}$</i> and <i>Electrical Characteristics: $V_S = \pm 5\text{ V}$</i> tables.....	6
• Updated distortion specifications in <i>Electrical Characteristics: $V_S = \pm 15\text{ V}$</i> and <i>Electrical Characteristics: $V_S = \pm 5\text{ V}$</i> tables.....	6

- Updated input voltage noise specifications in *Electrical Characteristics: $V_S = \pm 15\text{ V}$* and *Electrical Characteristics: $V_S = \pm 5\text{ V}$* tables..... 6
- Updated input current noise specifications in *Electrical Characteristics: $V_S = \pm 15\text{ V}$* and *Electrical Characteristics: $V_S = \pm 5\text{ V}$* tables..... 6
- Removed differential gain and differential phase specifications from *Electrical Characteristics: $V_S = \pm 15\text{ V}$* and *Electrical Characteristics: $V_S = \pm 5\text{ V}$* tables..... 6
- Updated transimpedance specifications in *Electrical Characteristics: $V_S = \pm 15\text{ V}$* and *Electrical Characteristics: $V_S = \pm 5\text{ V}$* tables..... 6
- Removed specifications with $T_A = 0^\circ\text{C}$ to 70°C test conditions in *Electrical Characteristics: $V_S = \pm 15\text{ V}$* and *Electrical Characteristics: $V_S = \pm 5\text{ V}$* tables..... 6
- Updated max input voltage specifications in *Electrical Characteristics: $V_S = \pm 15\text{ V}$* and *Electrical Characteristics: $V_S = \pm 5\text{ V}$* tables..... 6
- Updated max inverting input bias current specifications in *Electrical Characteristics: $V_S = \pm 15\text{ V}$* and *Electrical Characteristics: $V_S = \pm 5\text{ V}$* tables..... 6
- Updated max input offset current drift specifications in *Electrical Characteristics: $V_S = \pm 15\text{ V}$* and *Electrical Characteristics: $V_S = \pm 5\text{ V}$* tables..... 6
- Updated average offset voltage drift specifications in *Electrical Characteristics: $V_S = \pm 15\text{ V}$* and *Electrical Characteristics: $V_S = \pm 5\text{ V}$* tables..... 6
- Updated average bias current drift specifications in *Electrical Characteristics: $V_S = \pm 15\text{ V}$* and *Electrical Characteristics: $V_S = \pm 5\text{ V}$* tables..... 6
- Updated average offset current drift specifications in *Electrical Characteristics: $V_S = \pm 15\text{ V}$* and *Electrical Characteristics: $V_S = \pm 5\text{ V}$* tables..... 6
- Updated common-mode rejection ratio specifications in *Electrical Characteristics: $V_S = \pm 15\text{ V}$* and *Electrical Characteristics: $V_S = \pm 5\text{ V}$* tables..... 6
- Updated noninverting input resistance and capacitance specifications in *Electrical Characteristics: $V_S = \pm 15\text{ V}$* and *Electrical Characteristics: $V_S = \pm 5\text{ V}$* tables..... 6
- Updated output current specifications in *Electrical Characteristics: $V_S = \pm 15\text{ V}$* and *Electrical Characteristics: $V_S = \pm 5\text{ V}$* tables..... 6
- Removed specified operating voltage specifications from *Electrical Characteristics: $V_S = \pm 15\text{ V}$* and *Electrical Characteristics: $V_S = \pm 5\text{ V}$* tables..... 6
- Updated power supply rejection specifications in *Electrical Characteristics: $V_S = \pm 15\text{ V}$* and *Electrical Characteristics: $V_S = \pm 5\text{ V}$* tables..... 6
- Changed Electrical Characteristics THS3095 to *Electrical Characteristics: $V_S = \pm 5\text{ V}$* 8
- Removed *Dissipation Ratings* table..... 10
- Updated *Typical Characteristics ($\pm 15\text{ V}$)* section..... 10
- Updated *Typical Characteristics: ($\pm 5\text{ V}$)* section..... 16
- Updated *Feature Description* section..... 18
- Updated *Device Functional Modes* section..... 20
- Updated *Application and Implementation* section..... 21
- Updated *Typical Application* section..... 21
- Updated *Layout* section..... 24

Changes from Revision H (October 2015) to Revision I (December 2022)	Page
• Updated the numbering format for tables, figures, and cross-references throughout the document.....	1
• Added the <i>DGN</i> package information to the data sheet.....	1
• Added the <i>Device Comparison Table</i> section.....	4
• Updated <i>Thermal Information</i> table.....	5

5 Device Comparison Table

DEVICE	MAX SUPPLY, V_S (V)	SSBW, $A_V = 5$ (MHz)	MAXIMUM I_{CC} AT 25°C (mA)	INPUT NOISE V_n (nV/ $\sqrt{\text{Hz}}$)	SLEW RATE (V/ μs)	LINEAR OUTPUT CURRENT (mA)
THS3491	± 16	900	17.3	1.7	8000	± 420
THS3095	± 16	205	10.5	1.1	6000	± 310
OPA695	± 6	700 ($A_V = 4$)	13.3	1.8	4300	± 90
THS3001	± 16	350	7.5	1.6	6300	± 120
THS3115	± 15	100 ($A_V = 4$)	5.5	2.2	1550	± 270

6 Pin Configuration and Functions

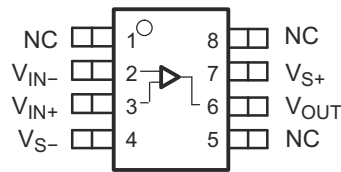

Figure 6-1. DGN or DDA Package, 8-Pin SOIC, HVSSOP or SO-PowerPAD THS3091 (Top View)

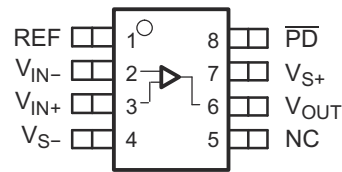

Figure 6-2. DDA Package, SO-PowerPAD THS3095 (Top View)

Table 6-1. Pin Functions

NAME	PIN NO.		TYPE ⁽¹⁾	DESCRIPTION
	THS3091	THS3095		
NC	1, 5, 8	5	—	No connection
PD	—	8	I	Amplifier power down Low = amplifier disabled High (default) = amplifier enabled
REF	—	1	I	Voltage reference input to set $\overline{\text{PD}}$ threshold level
V_{IN-}	2	2	I	Inverting input
V_{IN+}	3	3	I	Noninverting input
V_{OUT}	6	6	O	Output of amplifier
V_{S-}	4	4	P	Negative power supply
V_{S+}	7	7	P	Positive power supply

(1) I = input, O = output, POW = power, and NC = no internal connection

7 Specifications

7.1 Absolute Maximum Ratings

over operating free-air temperature range (unless otherwise noted)⁽¹⁾

		MIN	MAX	UNIT
V _S	Supply voltage		33	V
V _I	Input voltage		±V _S	V
V _{ID}	Differential input voltage		±4	V
I _O	Output current		350	mA
T _J ⁽²⁾	Junction temperature	Maximum	150	°C
		Continuous operation, long-term reliability	125	
T _{stg}	Storage temperature	–65	150	°C

- (1) Stresses beyond those listed under *Absolute Maximum Ratings* may cause permanent damage to the device. These are stress ratings only, which do not imply functional operation of the device at these or any other conditions beyond those indicated under *Recommended Operating Conditions*. Exposure to absolute-maximum-rated conditions for extended periods may affect device reliability.
- (2) The maximum junction temperature for continuous operation is limited by package constraints. Operation above this temperature can result in reduced reliability, reduced lifetime of the device, or both.

7.2 ESD Ratings

			VALUE	UNIT
V _(ESD)	Electrostatic discharge	Human-body model (HBM), per ANSI/ESDA/JEDEC JS-001 ⁽¹⁾	±2000	V
		Charged-device model (CDM), per ANSI/ESDA/JEDEC JS-002 ⁽²⁾	±1500	

- (1) JEDEC document JEP155 states that 500-V HBM allows safe manufacturing with a standard ESD control process.
- (2) JEDEC document JEP157 states that 250-V CDM allows safe manufacturing with a standard ESD control process.

7.3 Recommended Operating Conditions

over operating free-air temperature range (unless otherwise noted)

		MIN	NOM	MAX	UNIT	
V _S	Supply voltage	Dual supply	±5	±15	±16	V
		Single supply	10	30	32	
T _A	Operating free-air temperature	–40		85	°C	

7.4 Thermal Information

THERMAL METRIC ⁽¹⁾		THS309x	THS3091	UNIT
		DDA (SO PowerPAD)	DGN (HVSSOP)	
		8 PINS	8 PINS	
R _{θJA}	Junction-to-ambient thermal resistance	58.4	60.4	°C/W
R _{θJC(top)}	Junction-to-case (top) thermal resistance	72.0	87.2	°C/W
R _{θJB}	Junction-to-board thermal resistance	32.6	32.6	°C/W
ψ _{JT}	Junction-to-top characterization parameter	13.2	7.8	°C/W
ψ _{JB}	Junction-to-board characterization parameter	32.5	32.6	°C/W
R _{θJC(bot)}	Junction-to-case (bottom) thermal resistance	17.1	17.0	°C/W

- (1) For more information about traditional and new thermal metrics, see the [Semiconductor and IC Package Thermal Metrics](#) application report.

7.5 Electrical Characteristics: $V_S = \pm 15\text{ V}$

at $T_A \cong 25^\circ\text{C}$, $R_F = 1.21\text{ k}\Omega$, $R_L = 100\ \Omega$, and $G = 2$ (unless otherwise noted)

PARAMETER	TEST CONDITIONS		MIN	TYP	MAX	UNIT
AC PERFORMANCE						
Small-signal bandwidth, -3 dB	$G = 1$, $R_F = 1.78\text{ k}\Omega$, $V_O = 200\text{ mV}_{PP}$	DDA package		715		MHz
		DGN package		600		
	$G = 2$, $R_F = 1.21\text{ k}\Omega$, $V_O = 200\text{ mV}_{PP}$			305		
	$G = 5$, $R_F = 1\text{ k}\Omega$, $V_O = 200\text{ mV}_{PP}$			205		
	$G = 10$, $R_F = 866\ \Omega$, $V_O = 200\text{ mV}_{PP}$			190		
0.1-dB bandwidth flatness	$V_O = 200\text{ mV}_{PP}$			95		MHz
Large-signal bandwidth	$G = 5$, $R_F = 1\text{ k}\Omega$, $V_O = 4\text{ V}_{PP}$			135		MHz
Slew rate (10% to 90% level)	$G = 2$, $V_O = 10\text{-V step}$, $R_F = 1.21\text{ k}\Omega$			3600		V/ μs
	$G = 5$, $V_O = 20\text{-V step}$, $R_F = 1\text{ k}\Omega$			6000		
Rise and fall time	$V_O = 5\text{ V}_{PP}$			2		ns
Settling time	$G = -2$, $V_O = 2\text{-V}_{PP}$ step	to 0.1%		12.5		ns
		to 0.01%		18.5		
HARMONIC DISTORTION						
2nd harmonic distortion	$V_O = 2\text{ V}_{PP}$, $f = 10\text{ MHz}$	$R_L = 100\ \Omega$		72		dBc
		$R_L = 1\text{ k}\Omega$		84		
3rd harmonic distortion	$V_O = 2\text{ V}_{PP}$, $f = 10\text{ MHz}$	$R_L = 100\ \Omega$		70		dBc
		$R_L = 1\text{ k}\Omega$		99		
Input voltage noise	$f > 10\text{ kHz}$			1.1		nV/ $\sqrt{\text{Hz}}$
Noninverting input current noise	$f > 10\text{ kHz}$			15		pA/ $\sqrt{\text{Hz}}$
Inverting input current noise	$f > 10\text{ kHz}$			14		pA/ $\sqrt{\text{Hz}}$
DC PERFORMANCE						
Open-loop transimpedance	$V_O = \pm 7.5\text{ V}$, $G = 1$	$T_A = 25^\circ\text{C}$	350	1800		k Ω
		$T_A = -40^\circ\text{C to } +85^\circ\text{C}$	300			
Input offset voltage	$V_{CM} = 0\text{ V}$	$T_A = 25^\circ\text{C}$		0.9	3	mV
		$T_A = -40^\circ\text{C to } +85^\circ\text{C}$			5	
Noninverting input bias current	$V_{CM} = 0\text{ V}$	$T_A = 25^\circ\text{C}$		4	15	μA
		$T_A = -40^\circ\text{C to } +85^\circ\text{C}$			20	
Inverting input bias current	$V_{CM} = 0\text{ V}$	$T_A = 25^\circ\text{C}$		3.5	15	μA
		$T_A = -40^\circ\text{C to } +85^\circ\text{C}$			25	
Input offset current	$V_{CM} = 0\text{ V}$	$T_A = 25^\circ\text{C}$		1.7	20	μA
		$T_A = -40^\circ\text{C to } +85^\circ\text{C}$			30	
Average offset voltage drift	$V_{CM} = 0\text{ V}$, $T_A = -40^\circ\text{C to } +85^\circ\text{C}$			± 19		$\mu\text{V}/^\circ\text{C}$
Average noninverting bias current drift	$V_{CM} = 0\text{ V}$, $T_A = -40^\circ\text{C to } +85^\circ\text{C}$			± 20		nA/ $^\circ\text{C}$
Average inverting bias current drift	$V_{CM} = 0\text{ V}$, $T_A = -40^\circ\text{C to } +85^\circ\text{C}$			± 80		nA/ $^\circ\text{C}$
Average offset current drift	$V_{CM} = 0\text{ V}$, $T_A = -40^\circ\text{C to } +85^\circ\text{C}$			± 80		nA/ $^\circ\text{C}$

7.5 Electrical Characteristics: $V_S = \pm 15\text{ V}$ (continued)

at $T_A \approx 25^\circ\text{C}$, $R_F = 1.21\text{ k}\Omega$, $R_L = 100\ \Omega$, and $G = 2$ (unless otherwise noted)

PARAMETER	TEST CONDITIONS		MIN	TYP	MAX	UNIT
INPUT CHARACTERISTICS						
Common-mode input range	$T_A = 25^\circ\text{C}$		± 13.3	± 13.6		V
	$T_A = -40^\circ\text{C to } +85^\circ\text{C}$		± 13			
Common-mode rejection ratio	$V_{CM} = \pm 10\text{ V}$	$T_A = 25^\circ\text{C}$	62	78		dB
		$T_A = -40^\circ\text{C to } +85^\circ\text{C}$	59			
Noninverting input resistance				0.7		M Ω
Noninverting input capacitance				2.4		pF
Inverting input resistance				30		Ω
Inverting input capacitance				1.4		pF
OUTPUT CHARACTERISTICS						
Output voltage swing	$R_L = 1\text{ k}\Omega$	$T_A = 25^\circ\text{C}$	± 12.8	± 13.2		V
		$T_A = -40^\circ\text{C to } +85^\circ\text{C}$	± 12.5			
	$R_L = 100\ \Omega$	$T_A = 25^\circ\text{C}$	± 12.1	± 12.5		
		$T_A = -40^\circ\text{C to } +85^\circ\text{C}$	± 11.8			
Output current	Sourcing, $R_L = 40\ \Omega$	$T_A = 25^\circ\text{C}$	225	310		mA
		$T_A = -40^\circ\text{C to } +85^\circ\text{C}$	200			
	Sinking, $R_L = 40\ \Omega$	$T_A = 25^\circ\text{C}$	200	310		
		$T_A = -40^\circ\text{C to } +85^\circ\text{C}$	175			
Output impedance	$f = 1\text{ MHz, closed loop}$			0.06		Ω
POWER SUPPLY						
Quiescent current	$T_A = 25^\circ\text{C}$		8.5	9.5	10.5	mA
	$T_A = -40^\circ\text{C to } +85^\circ\text{C}$		8		11	
Power supply rejection	+PSRR	$T_A = 25^\circ\text{C}$	70	85		dB
		$T_A = -40^\circ\text{C to } +85^\circ\text{C}$	65			
	-PSRR	$T_A = 25^\circ\text{C}$	68	82		
		$T_A = -40^\circ\text{C to } +85^\circ\text{C}$	65			
POWER-DOWN CHARACTERISTICS (THS3095 ONLY)						
REF voltage range ⁽¹⁾			V_{S-}	$V_{S+} - 4$		V
Power-down voltage level ⁽¹⁾	Enable		$\overline{PD} \geq \text{REF} + 2$			V
	Disable		$\overline{PD} \leq \text{REF} + 0.8$			
Power-down quiescent current	$\overline{PD} = 0\text{ V}$	$T_A = 25^\circ\text{C}$		500	700	μA
		$T_A = -40^\circ\text{C to } +85^\circ\text{C}$			800	
PD bias current	$\overline{PD} = 0\text{ V, REF} = 0\text{ V,}$	$T_A = 25^\circ\text{C}$		11	15	μA
		$T_A = -40^\circ\text{C to } +85^\circ\text{C}$			20	
	$\overline{PD} = 3.3\text{ V, REF} = 0\text{ V}$	$T_A = 25^\circ\text{C}$		11	15	
		$T_A = -40^\circ\text{C to } +85^\circ\text{C}$			20	
Turn-on time delay	90% of final value			60		μs
Turn-off time delay	10% of final value			150		

(1) For detailed information on the behavior of the power-down circuit, see [Section 8.3.1](#).

7.6 Electrical Characteristics: $V_S = \pm 5\text{ V}$

at $T_A \cong 25^\circ\text{C}$, $R_F = 1.15\text{ k}\Omega$, $R_L = 100\ \Omega$, and $G = 2$ (unless otherwise noted)

PARAMETER	TEST CONDITIONS		MIN	TYP	MAX	UNIT
AC PERFORMANCE						
Small-signal bandwidth, -3 dB	$G = 1$, $R_F = 1.78\text{ k}\Omega$, $V_O = 200\text{ mV}_{PP}$	DDA package		485		MHz
		DGN package		435		
	$G = 2$, $R_F = 1.15\text{ k}\Omega$, $V_O = 200\text{ mV}_{PP}$			215		
	$G = 5$, $R_F = 1\text{ k}\Omega$, $V_O = 200\text{ mV}_{PP}$			160		
$G = 10$, $R_F = 866\ \Omega$, $V_O = 200\text{ mV}_{PP}$			160			
0.1-dB bandwidth flatness	$V_O = 200\text{ mV}_{PP}$			50		MHz
Large-signal bandwidth	$V_O = 4\text{ V}_{PP}$			205		MHz
Slew rate (10% to 90% level)	$G = 2$, $V_O = 5\text{-V step}$, $R_F = 1.21\text{ k}\Omega$			1800		V/ μs
	$G = 5$, $V_O = 5\text{-V step}$, $R_F = 1.21\text{ k}\Omega$			1700		
Rise and fall time	$G = 2$, $V_O = 5\text{-V step}$, $R_F = 1.21\text{ k}\Omega$			2		ns
Settling time	$G = -2$, $V_O = 2\text{-V}_{PP}$ step	to 0.1%		12.5		ns
		to 0.01%		26		
HARMONIC DISTORTION						
2nd harmonic distortion	$V_O = 2\text{ V}_{PP}$, $f = 10\text{ MHz}$	$R_L = 100\ \Omega$		74		dBc
		$R_L = 1\text{ k}\Omega$		76		
3rd harmonic distortion	$V_O = 2\text{ V}_{PP}$, $f = 10\text{ MHz}$	$R_L = 100\ \Omega$		70		dBc
		$R_L = 1\text{ k}\Omega$		75		
Input voltage noise	$f > 10\text{ kHz}$			1.1		nV/ $\sqrt{\text{Hz}}$
Noninverting input current noise	$f > 10\text{ kHz}$			15		pA/ $\sqrt{\text{Hz}}$
Inverting input current noise	$f > 10\text{ kHz}$			14		pA/ $\sqrt{\text{Hz}}$
DC PERFORMANCE						
Open-loop transimpedance	$V_O = \pm 2.5\text{ V}$, $G = 1$	$T_A = 25^\circ\text{C}$	250	1500		k Ω
		$T_A = -40^\circ\text{C to } +85^\circ\text{C}$	200			
Input offset voltage	$V_{CM} = 0\text{ V}$	$T_A = 25^\circ\text{C}$		0.6	2	mV
		$T_A = -40^\circ\text{C to } +85^\circ\text{C}$			3.5	
Noninverting input bias current	$V_{CM} = 0\text{ V}$	$T_A = 25^\circ\text{C}$		2	15	μA
		$T_A = -40^\circ\text{C to } +85^\circ\text{C}$			20	
Inverting input bias current	$V_{CM} = 0\text{ V}$	$T_A = 25^\circ\text{C}$		5	15	μA
		$T_A = -40^\circ\text{C to } +85^\circ\text{C}$			25	
Input offset current	$V_{CM} = 0\text{ V}$	$T_A = 25^\circ\text{C}$		1.5	10	μA
		$T_A = -40^\circ\text{C to } +85^\circ\text{C}$			20	
Average offset voltage drift	$V_{CM} = 0\text{ V}$, $T_A = -40^\circ\text{C to } +85^\circ\text{C}$			± 20		$\mu\text{V}/^\circ\text{C}$
Average noninverting bias current drift	$V_{CM} = 0\text{ V}$, $T_A = -40^\circ\text{C to } +85^\circ\text{C}$			± 20		nA/ $^\circ\text{C}$
Average inverting bias current drift	$V_{CM} = 0\text{ V}$, $T_A = -40^\circ\text{C to } +85^\circ\text{C}$			± 95		nA/ $^\circ\text{C}$
Average offset current drift	$V_{CM} = 0\text{ V}$, $T_A = -40^\circ\text{C to } +85^\circ\text{C}$			± 90		nA/ $^\circ\text{C}$

7.6 Electrical Characteristics: $V_S = \pm 5\text{ V}$ (continued)

at $T_A \approx 25^\circ\text{C}$, $R_F = 1.15\text{ k}\Omega$, $R_L = 100\ \Omega$, and $G = 2$ (unless otherwise noted)

PARAMETER	TEST CONDITIONS		MIN	TYP	MAX	UNIT
INPUT CHARACTERISTICS						
Common-mode input range	$T_A = 25^\circ\text{C}$		± 3.3	± 3.6		V
	$T_A = -40^\circ\text{C}$ to $+85^\circ\text{C}$		± 3			
Common-mode rejection ratio	$V_{CM} = \pm 2.0\text{ V}$, $V_O = 0\text{ V}$	$T_A = 25^\circ\text{C}$	60	66		dB
		$T_A = -40^\circ\text{C}$ to $+85^\circ\text{C}$	57			
Noninverting input resistance				0.45		M Ω
Noninverting input capacitance				2.6		pF
Inverting input resistance				32		Ω
Inverting input capacitance				1.5		pF
OUTPUT CHARACTERISTICS						
Output voltage swing	$R_L = 1\text{ k}\Omega$	$T_A = 25^\circ\text{C}$	± 3.1	± 3.4		V
		$T_A = -40^\circ\text{C}$ to $+85^\circ\text{C}$	± 2.8			
Output voltage swing	$R_L = 100\ \Omega$	$T_A = 25^\circ\text{C}$	± 2.7	± 3.1		V
		$T_A = -40^\circ\text{C}$ to $+85^\circ\text{C}$	± 2.5			
Output current	Sourcing, $R_L = 10\ \Omega$	$T_A = 25^\circ\text{C}$	140	250		mA
		$T_A = -40^\circ\text{C}$ to $+85^\circ\text{C}$	120			
	Sinking, $R_L = 10\ \Omega$	$T_A = 25^\circ\text{C}$	-140	-250		
		$T_A = -40^\circ\text{C}$ to $+85^\circ\text{C}$	-120			
Output impedance	$f = 1\text{ MHz}$, closed loop			0.09		Ω
POWER SUPPLY						
Quiescent current	$T_A = 25^\circ\text{C}$		7	8.2	9	mA
	$T_A = -40^\circ\text{C}$ to $+85^\circ\text{C}$		6.5		9.5	
Power supply rejection	+PSRR	$T_A = 25^\circ\text{C}$	68	81		dB
		$T_A = -40^\circ\text{C}$ to $+85^\circ\text{C}$	63			
	-PSRR	$T_A = 25^\circ\text{C}$	65	79		
		$T_A = -40^\circ\text{C}$ to $+85^\circ\text{C}$	60			
POWER-DOWN CHARACTERISTICS (THS3095 ONLY)						
REF voltage range ⁽¹⁾			V_{S-}		$V_{S+} - 4$	V
Power-down voltage level ⁽¹⁾	Enable		$\overline{PD} \geq \text{REF} + 2$			V
	Disable		$\overline{PD} \leq \text{REF} + 0.8$			
Power-down quiescent current	$\overline{PD} = 0\text{ V}$	$T_A = 25^\circ\text{C}$		300	500	μA
		$T_A = -40^\circ\text{C}$ to $+85^\circ\text{C}$			600	
PD bias current	$\overline{PD} = 0\text{ V}$, $\text{REF} = 0\text{ V}$,	$T_A = 25^\circ\text{C}$		11	15	μA
		$T_A = -40^\circ\text{C}$ to $+85^\circ\text{C}$			20	
	$\overline{PD} = 3.3\text{ V}$, $\text{REF} = 0\text{ V}$	$T_A = 25^\circ\text{C}$		11	15	
		$T_A = -40^\circ\text{C}$ to $+85^\circ\text{C}$			20	
Turn-on time delay	90% of final value			60		μs
Turn-off time delay	10% of final value			150		μs

(1) For detailed information on the behavior of the power-down circuit, see [Section 8.3.1](#).

7.7 Typical Characteristics: ±15 V

at $T_A \approx 25^\circ\text{C}$, $V_S = \pm 15\text{ V}$, $R_F = 1.21\text{ k}\Omega$, $G = +2\text{ V/V}$, and $R_L = 100\ \Omega$ (unless otherwise noted)

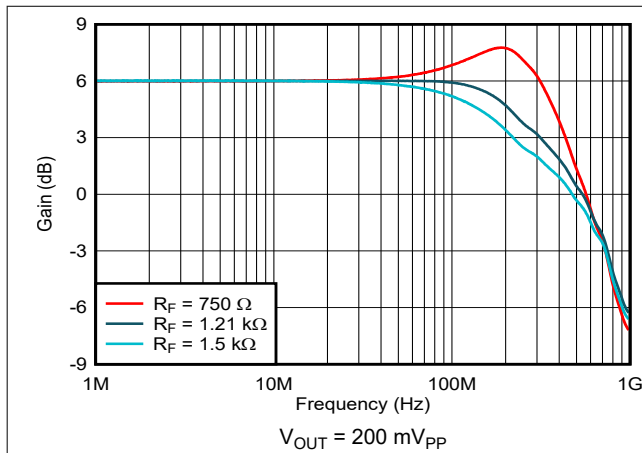

Figure 7-1. Noninverting Small-Signal Frequency Response

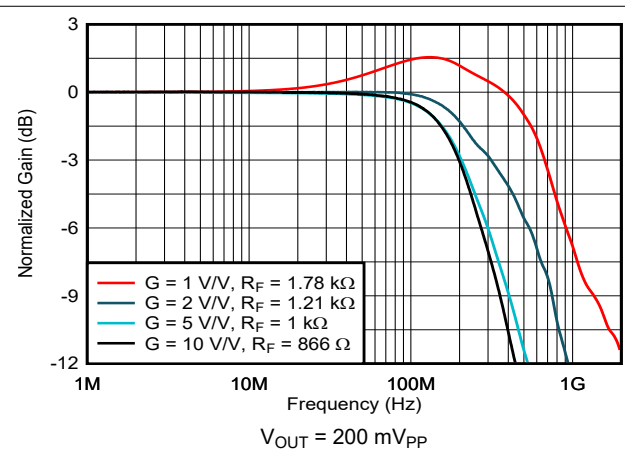

Figure 7-2. Noninverting Small-Signal Frequency Response

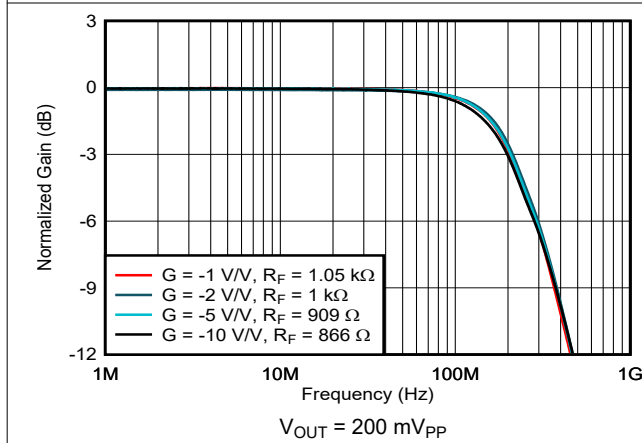

Figure 7-3. Inverting Small-Signal Frequency Response

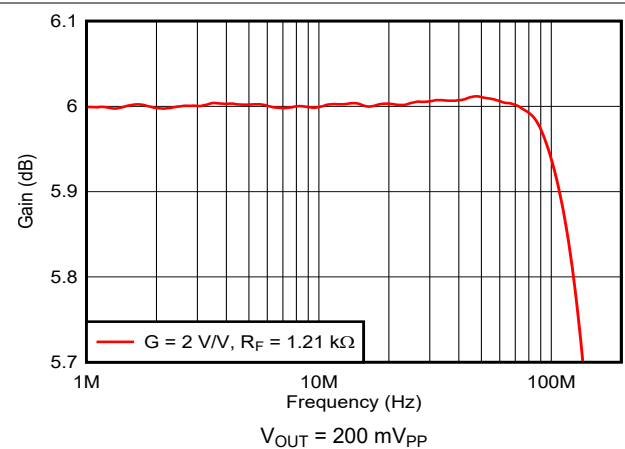

Figure 7-4. 0.1-dB Gain Flatness Frequency Response

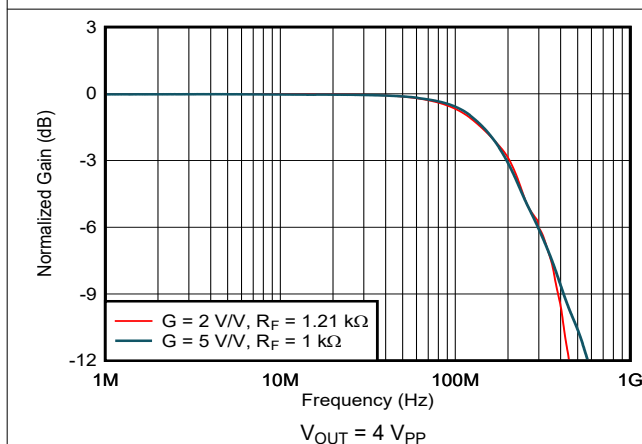

Figure 7-5. Noninverting Large-Signal Frequency Response

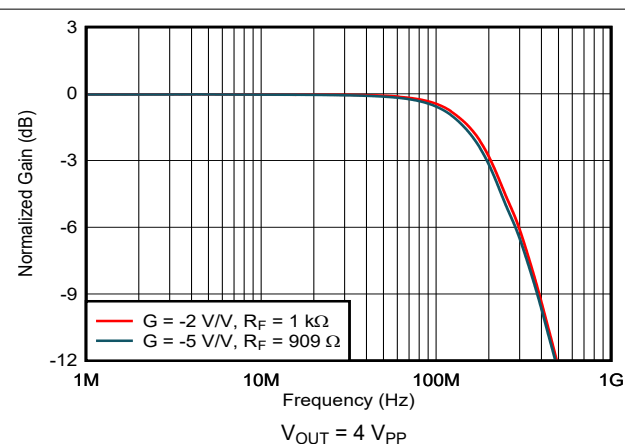

Figure 7-6. Inverting Large-Signal Frequency Response

7.7 Typical Characteristics: ±15 V (continued)

at $T_A \approx 25^\circ\text{C}$, $V_S = \pm 15\text{ V}$, $R_F = 1.21\text{ k}\Omega$, $G = +2\text{ V/V}$, and $R_L = 100\ \Omega$ (unless otherwise noted)

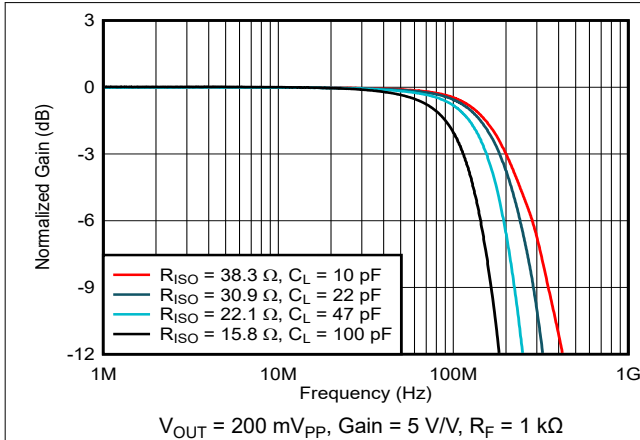

Figure 7-7. Capacitive Load Frequency Response

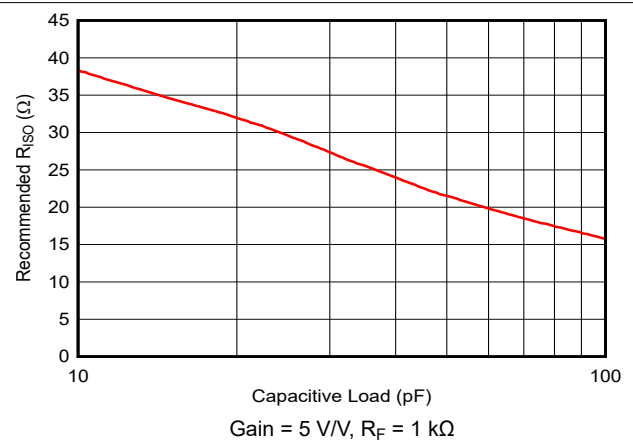

Figure 7-8. Recommended R_{ISO} vs Capacitive Load

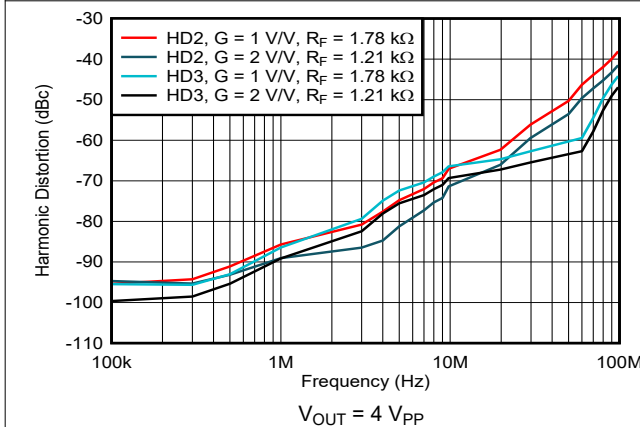

Figure 7-9. Harmonic Distortion vs Frequency

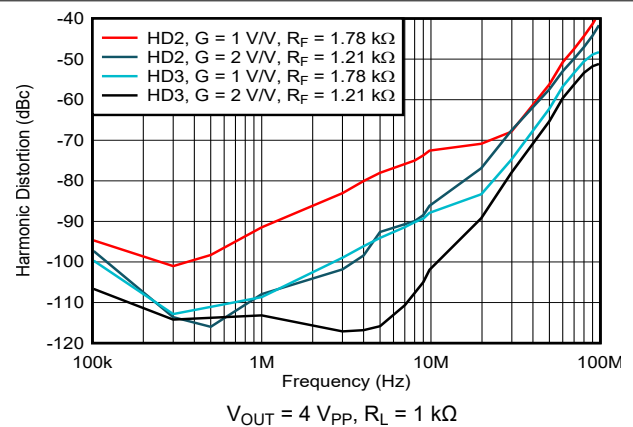

Figure 7-10. Harmonic Distortion vs Frequency

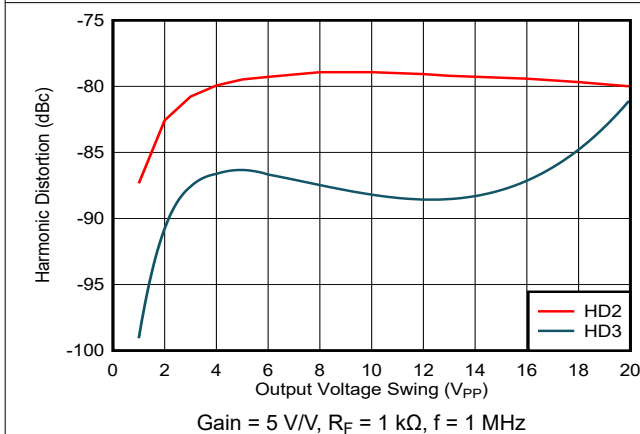

Figure 7-11. Harmonic Distortion vs Output Voltage Swing

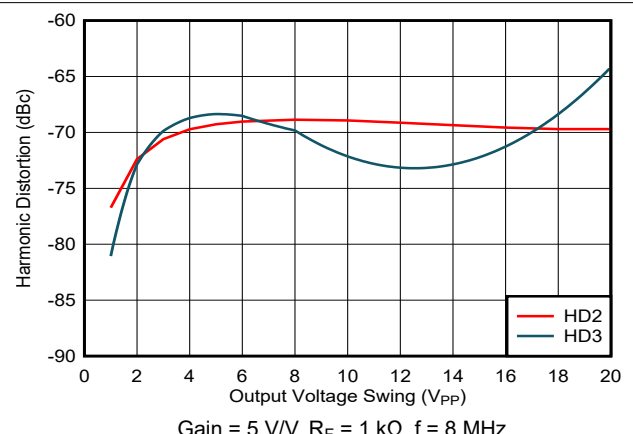

Figure 7-12. Harmonic Distortion vs Output Voltage Swing

7.7 Typical Characteristics: ±15 V (continued)

at $T_A \approx 25^\circ\text{C}$, $V_S = \pm 15\text{ V}$, $R_F = 1.21\text{ k}\Omega$, $G = +2\text{ V/V}$, and $R_L = 100\ \Omega$ (unless otherwise noted)

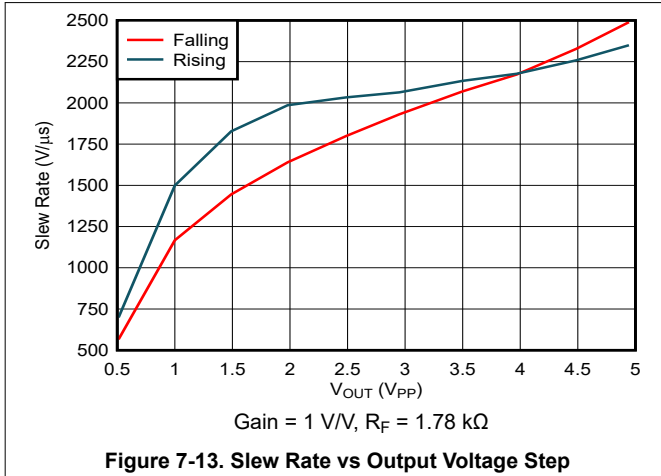

Figure 7-13. Slew Rate vs Output Voltage Step

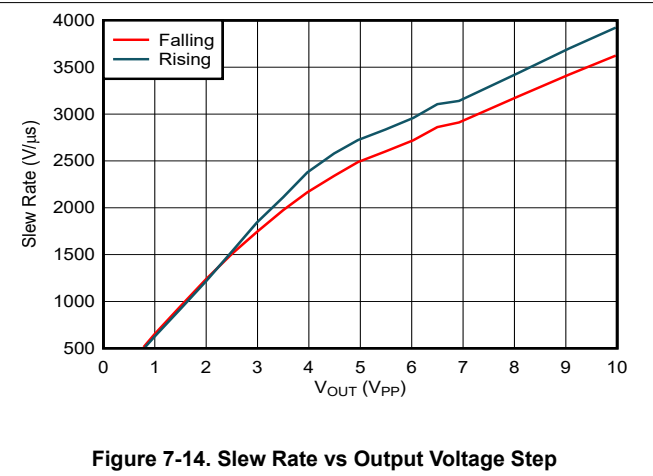

Figure 7-14. Slew Rate vs Output Voltage Step

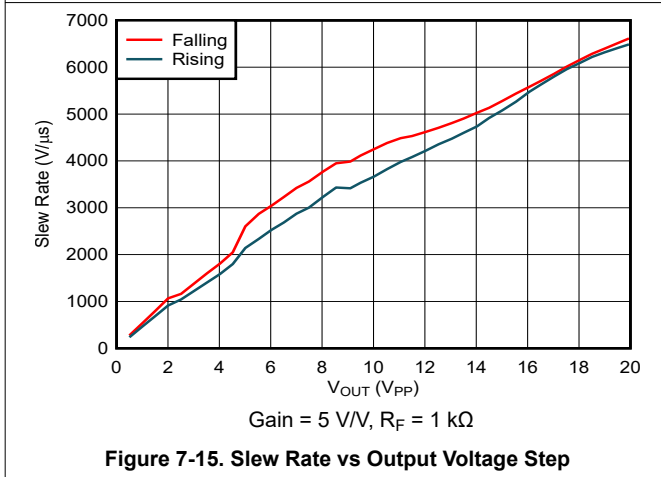

Figure 7-15. Slew Rate vs Output Voltage Step

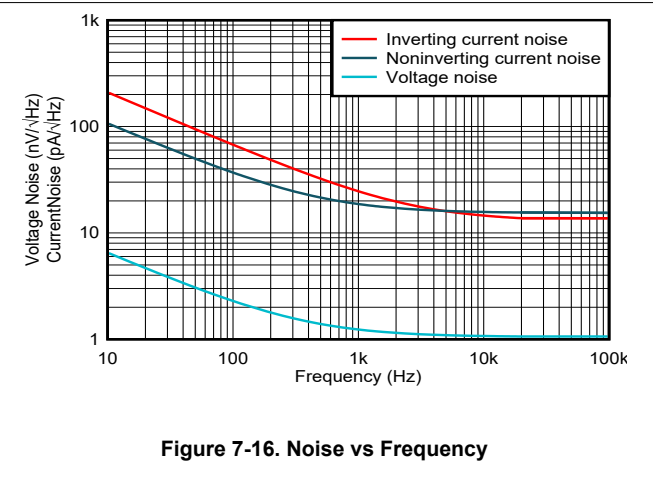

Figure 7-16. Noise vs Frequency

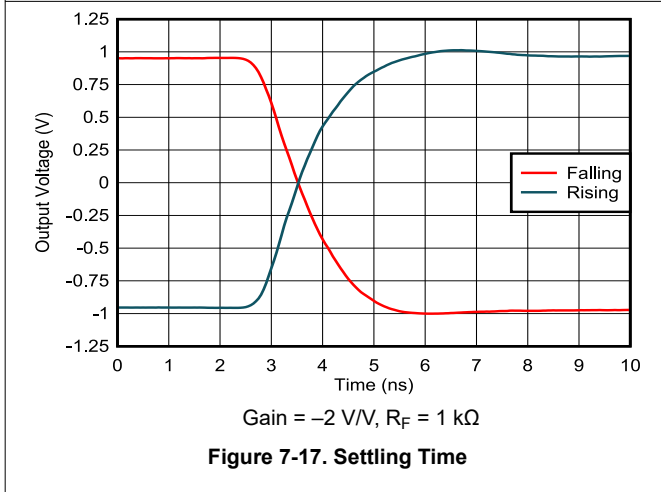

Figure 7-17. Settling Time

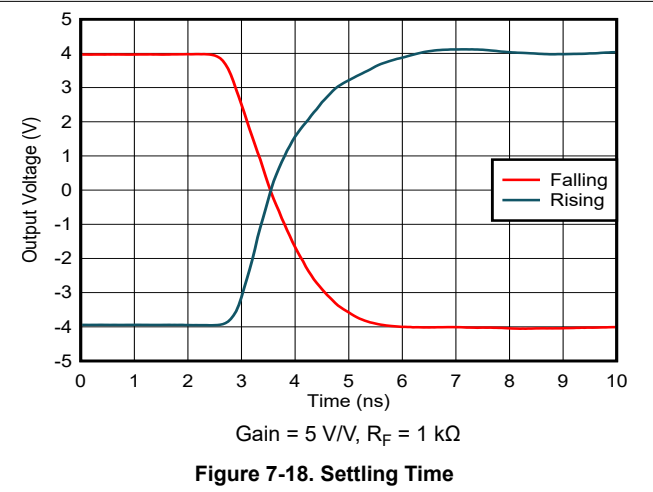

Figure 7-18. Settling Time

7.7 Typical Characteristics: ±15 V (continued)

at $T_A \approx 25^\circ\text{C}$, $V_S = \pm 15\text{ V}$, $R_F = 1.21\text{ k}\Omega$, $G = +2\text{ V/V}$, and $R_L = 100\ \Omega$ (unless otherwise noted)

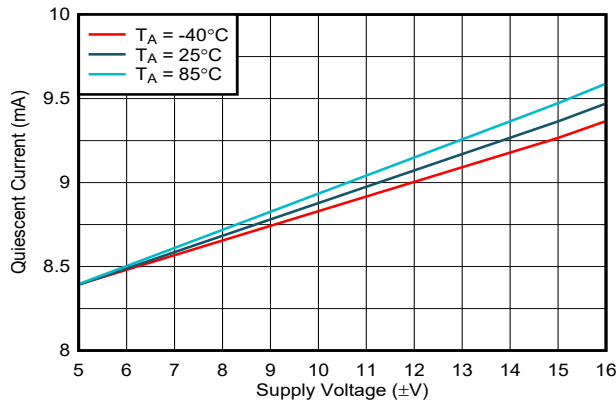

Figure 7-19. Quiescent Current vs Supply Voltage

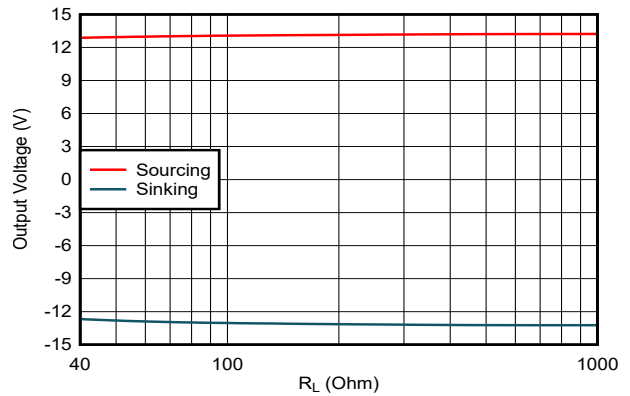

Figure 7-20. Output Voltage vs Load Resistance

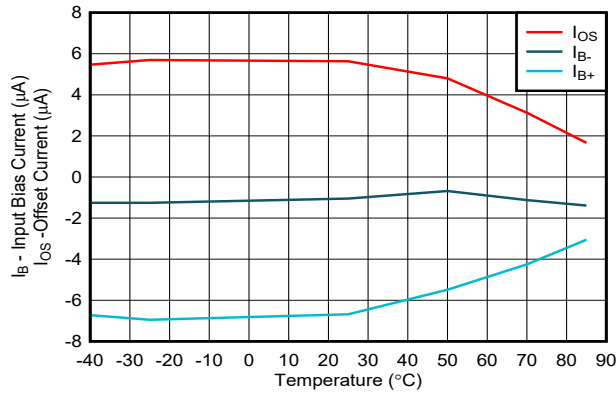

Figure 7-21. Input Bias and Offset Current vs Case Temperature

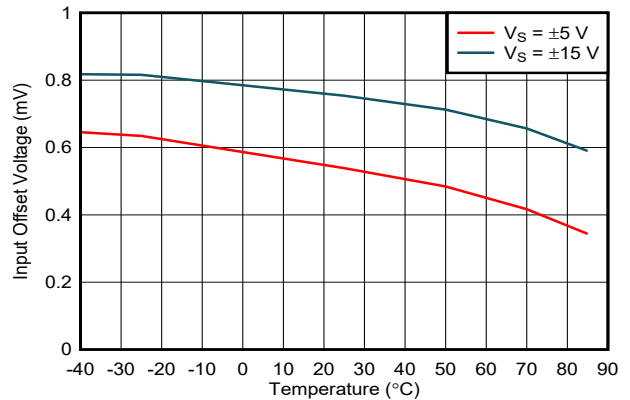

Figure 7-22. Input Offset Voltage vs Case Temperature

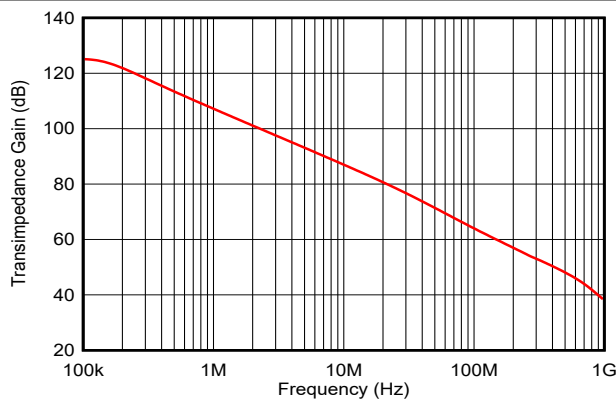

Figure 7-23. Transimpedance vs Frequency

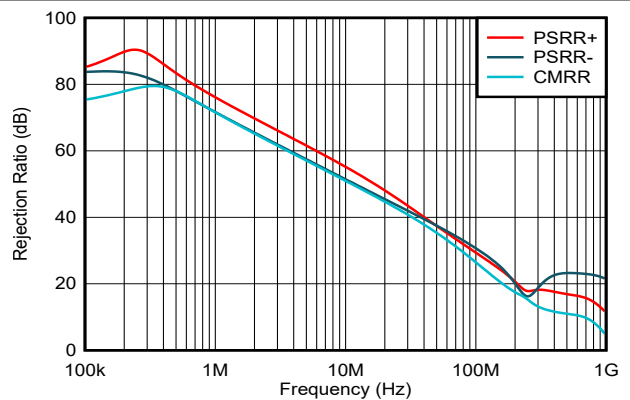

Figure 7-24. Rejection Ratio vs Frequency

7.7 Typical Characteristics: ±15 V (continued)

at $T_A \approx 25^\circ\text{C}$, $V_S = \pm 15\text{ V}$, $R_F = 1.21\text{ k}\Omega$, $G = +2\text{ V/V}$, and $R_L = 100\ \Omega$ (unless otherwise noted)

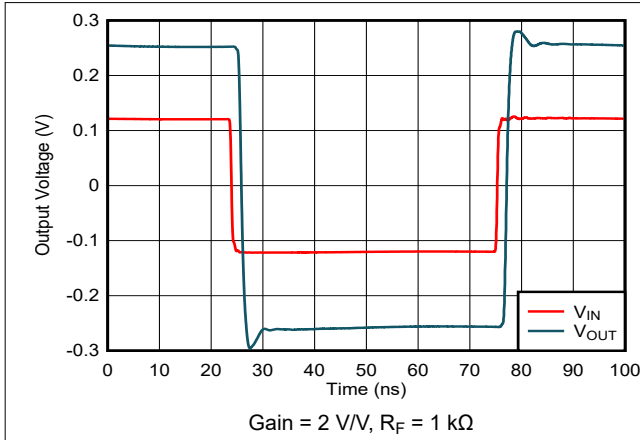

Figure 7-25. Noninverting Small-Signal Transient Response

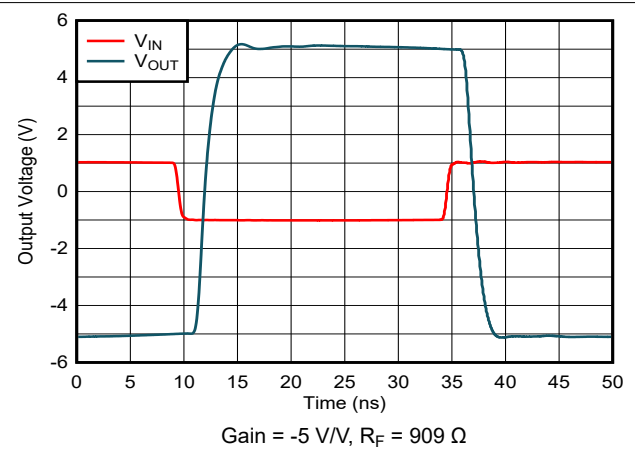

Figure 7-26. Inverting Large-Signal Transient Response

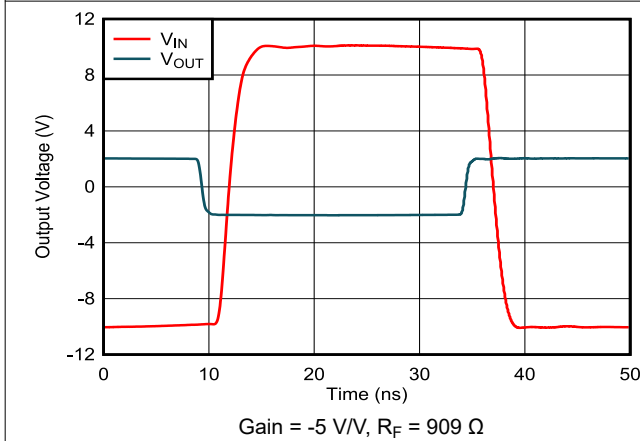

Figure 7-27. Inverting Large-Signal Transient Response

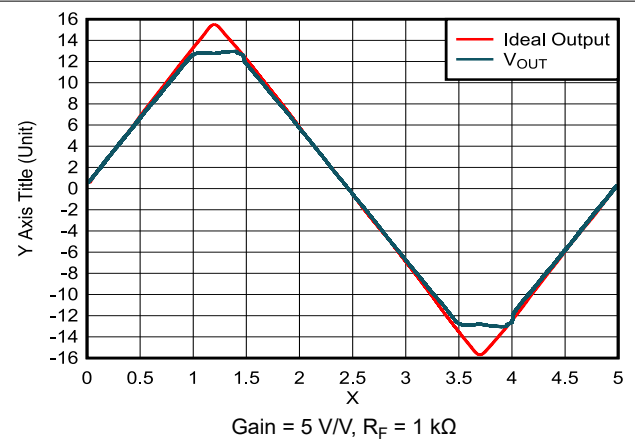

Figure 7-28. Output Overdrive Recovery Time

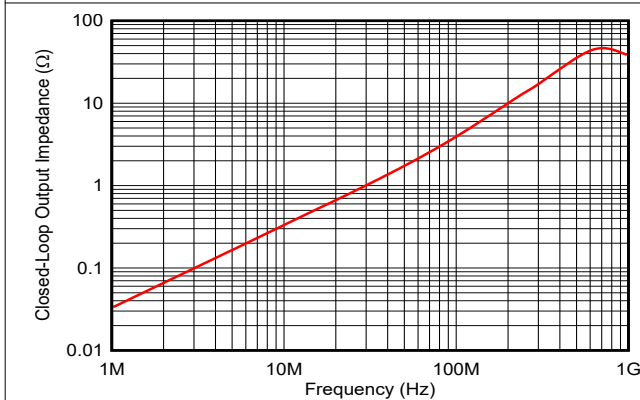

Figure 7-29. Closed-Loop Output Impedance vs Frequency

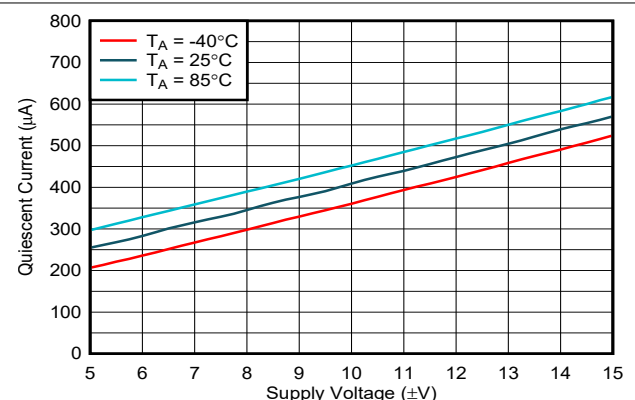
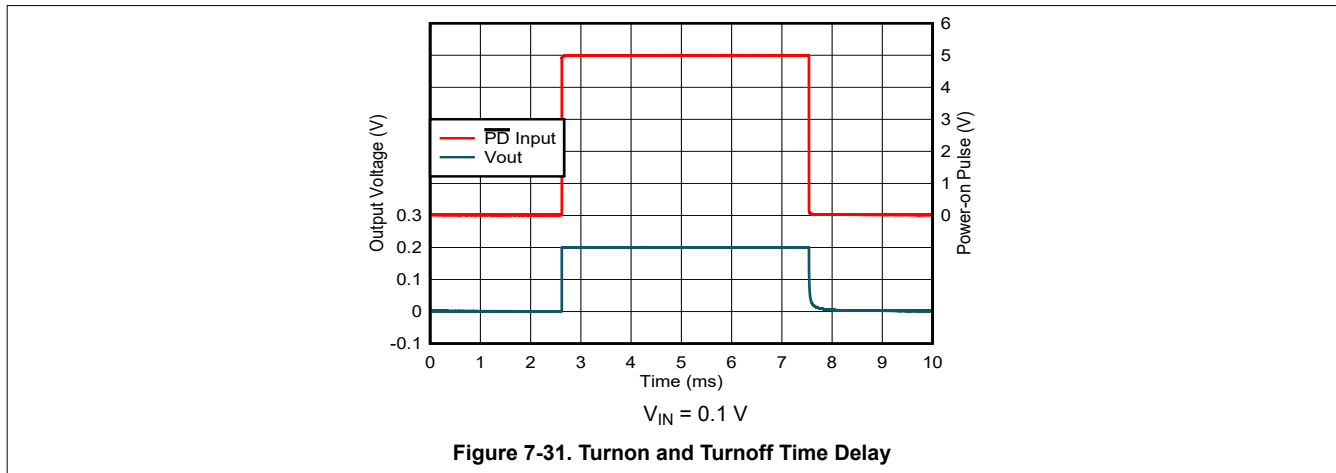

Figure 7-30. Power-Down Quiescent Current vs Supply Voltage

7.7 Typical Characteristics: ± 15 V (continued)

at $T_A \cong 25^\circ\text{C}$, $V_S = \pm 15$ V, $R_F = 1.21$ k Ω , $G = +2$ V/V, and $R_L = 100$ Ω (unless otherwise noted)



7.8 Typical Characteristics: ±5 V

at $T_A \approx 25^\circ\text{C}$, $V_S = \pm 5\text{ V}$, $R_F = 1.15\text{ k}\Omega$, $G = +2\text{ V/V}$, and $R_L = 100\ \Omega$ (unless otherwise noted)

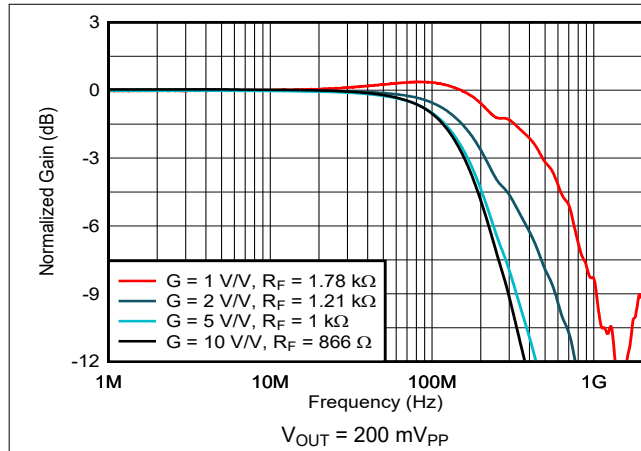

Figure 7-32. Noninverting Small-Signal Frequency Response

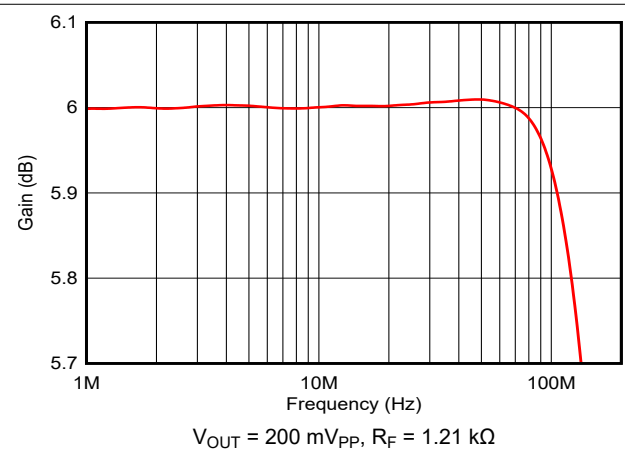

Figure 7-33. 0.1-dB Gain Flatness Frequency Response

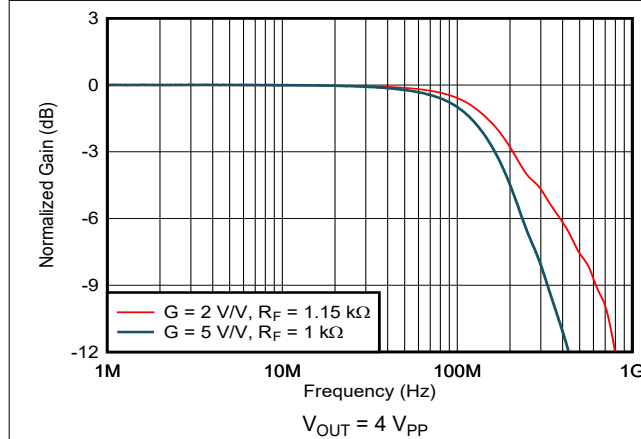

Figure 7-34. Noninverting Large-Signal Frequency Response

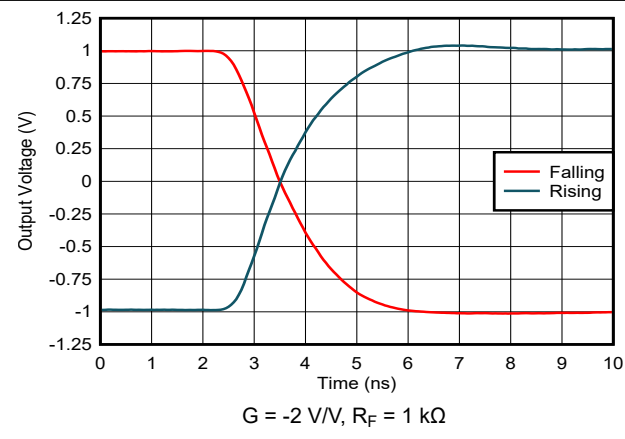

Figure 7-35. Settling Time

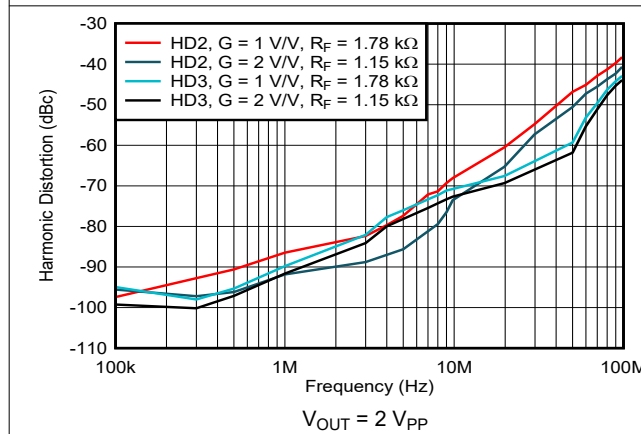

Figure 7-36. Harmonic Distortion vs Frequency

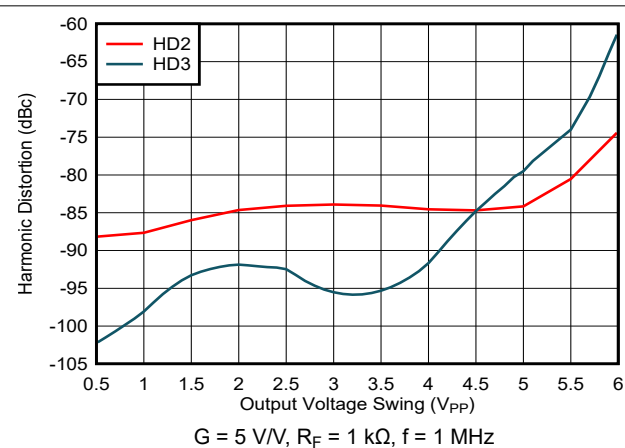

Figure 7-37. Harmonic Distortion vs Output Voltage Swing

7.8 Typical Characteristics: ± 5 V (continued)

at $T_A \approx 25^\circ\text{C}$, $V_S = \pm 5$ V, $R_F = 1.15$ k Ω , $G = +2$ V/V, and $R_L = 100$ Ω (unless otherwise noted)

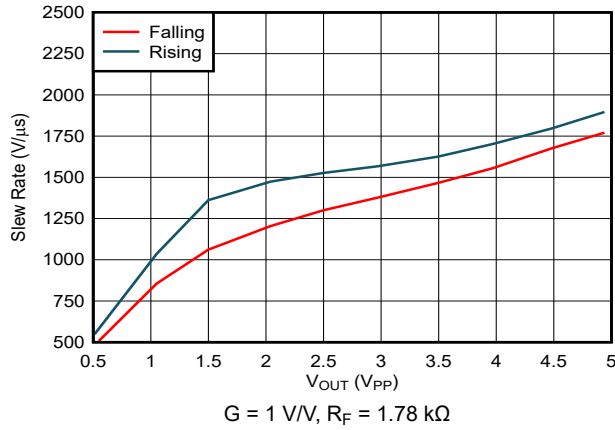

Figure 7-38. Slew Rate vs Output Voltage Step

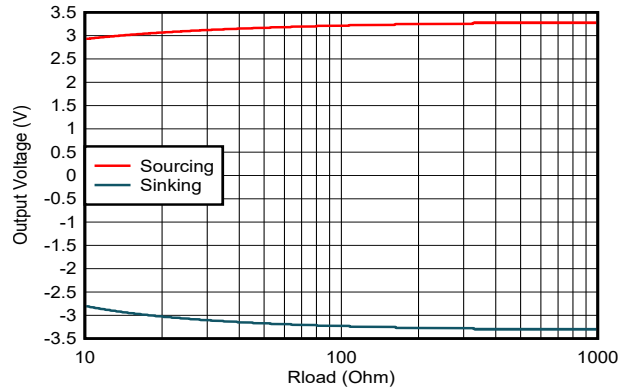

Figure 7-39. Output Voltage vs Load Resistance

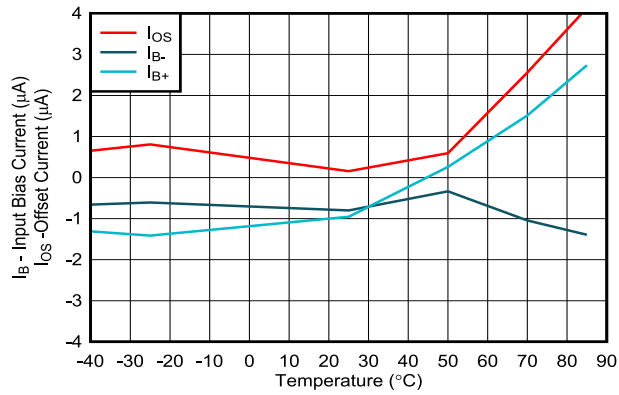

Figure 7-40. Input Bias and Offset Current vs Case Temperature

8 Detailed Description

8.1 Overview

The THS3091 and THS3095 (THS309x) are high-voltage, low-distortion, high-speed, current feedback amplifiers. The THS309x are designed to operate over a wide supply range of $\pm 5\text{ V}$ to $\pm 16\text{ V}$ for applications requiring large, linear output swings, such as arbitrary waveform generators.

The THS3095 also features a power-down pin that puts the amplifier into a low-power standby mode, and lowers the quiescent current from 9.5 mA to 500 μA .

8.2 Functional Block Diagram

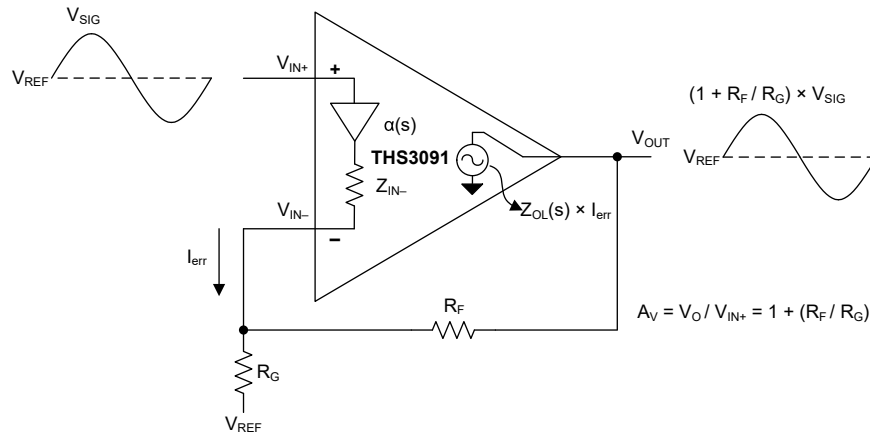

8.3 Feature Description

8.3.1 Power-Down and Reference Pins Functionality

The THS3095 features a power-down pin ($\overline{\text{PD}}$) designed to reduce system power that lowers the quiescent current from 9.5 mA down to 500 μA . The THS3095 also features a reference pin (REF) that allows the user to control the enable or disable power-down voltage levels applied to the $\overline{\text{PD}}$ pin.

The power-down pin of the amplifier defaults to the positive supply voltage in the absence of an applied voltage, putting the amplifier in the power-on mode of operation. Driving the power-down pin towards the negative rail will turn off the amplifier and conserve power. The following equations show the relationship between the reference voltage and the power-down thresholds:

$$\overline{\text{PD}} \leq \text{REF} + 0.8\text{ V for disable} \quad (1)$$

$$\overline{\text{PD}} \leq \text{REF} + 2.0\text{ V for enable} \quad (2)$$

where the usable range at the REF pin is:

$$V_{S-} \leq V_{\text{REF}} \leq (V_{S+} - 4\text{ V}) \quad (3)$$

The recommended mode of operation is to tie the REF pin to midrail, thus setting the disable or enable thresholds to the following equations:

$$V_{\text{midrail}} + 0.8\text{ V} \quad (4)$$

$$V_{\text{midrail}} + 2\text{ V} \quad (5)$$

Power-Down mode is not intended to provide a high-impedance output. In other words, the power-down functionality is not intended to allow use as a tri-state bus driver. When in Power-Down mode, the impedance at the output of the amplifier is dominated by the feedback and gain-setting resistors, but the output impedance of the device varies depending on the voltage applied to the outputs.

Figure 8-1 shows the total system output impedance, which includes the amplifier output impedance in parallel with the feedback plus gain resistors, and cumulates to 2416 Ω . Figure 8-2 shows this circuit configuration for reference.

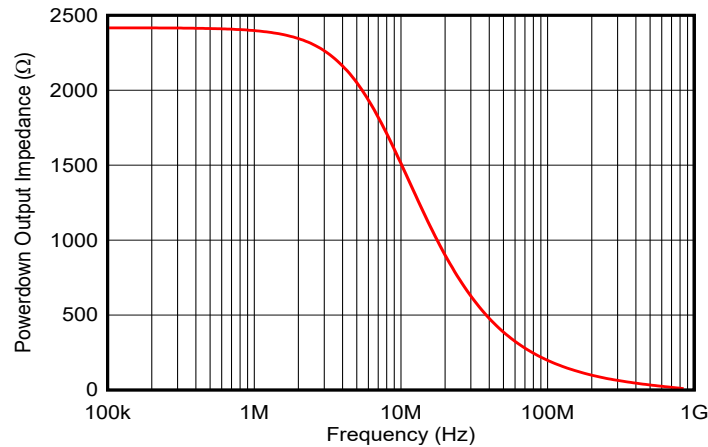

Figure 8-1. Power-Down Output Impedance vs Frequency

As with most current feedback amplifiers, the internal architecture places some limitations on the system when in Power-Down mode. Most notably is the fact that the amplifier actually turns on if there is a ± 0.7 V or greater difference between the two input nodes (V_{IN+} and V_{IN-}) of the amplifier. If this difference exceeds ± 0.7 V, then the output of the amplifier creates an output voltage equal to approximately $[(V_{IN+} - V_{IN-}) - 0.7 \text{ V}] \times \text{Gain}$. This also implies that if a voltage is applied to the output while in Power-Down mode, the $V-$ node voltage is equal to $V_{O(\text{applied})} \times R_G / (R_F + R_G)$. For low-gain configurations and a large applied voltage at the output, the amplifier can actually turn on due to the aforementioned behavior.

The time delays associated with turning the device on and off are specified as the time required for the amplifier to reach either 10% or 90% of the final output voltage. The time delays are in the order of microseconds because the amplifier moves in and out of the linear mode of operation in these transitions.

8.4 Device Functional Modes

8.4.1 Wideband, Noninverting Operation

The THS309x are unity gain stable 715-MHz current-feedback operational amplifiers designed to operate from a $\pm 5\text{-V}$ to $\pm 15\text{-V}$ power supply. Figure 8-2 shows the THS3091 in a noninverting gain of 2-V/V configuration typically used to generate the performance curves. Most of the curves were characterized using signal sources with a 50- Ω source impedance, and with measurement equipment presenting a 50- Ω load impedance.

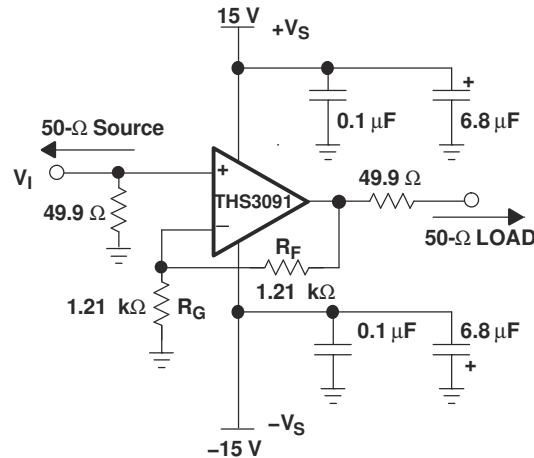

Figure 8-2. Wideband, Noninverting Gain Configuration

Current-feedback amplifiers are highly dependent on feedback resistor R_F for maximum performance and stability. Table 8-1 shows the optimal gain-setting resistors R_F and R_G at different gains to give maximum bandwidth with minimal peaking in the frequency response. Higher bandwidths can be achieved (at the expense of added peaking in the frequency response) by using even lower values for R_F . Conversely, increasing R_F decreases the bandwidth, but improves stability.

Table 8-1. Recommended Resistor Values for Optimum Frequency Response

THS3091 AND THS3095 R_F AND R_G VALUES FOR MINIMAL PEAKING WITH $R_L = 100 \Omega$			
GAIN (V/V)	SUPPLY VOLTAGE (V)	R_G (Ω)	R_F (Ω)
1	± 5 and ± 15	—	1.78 k
2	± 5	1.15 k	1.15 k
	± 15	1.21 k	1.21 k
5	± 5 and ± 15	249	1 k
10	± 5 and ± 15	95.3	866
-1	± 5 and ± 15	1.05 k	1.05 k
-2	± 5 and ± 15	499	1 k
-5	± 5 and ± 15	182	909
-10	± 5 and ± 15	86.6	866

9 Application and Implementation

Note

Information in the following applications sections is not part of the TI component specification, and TI does not warrant its accuracy or completeness. TI's customers are responsible for determining suitability of components for their purposes, as well as validating and testing their design implementation to confirm system functionality.

9.1 Application Information

9.2 Typical Application

The fundamental concept of load sharing is to drive a load using two or more of the same operational amplifiers. Each amplifier is driven by the same source. Figure 9-1 illustrates the schematic for this design. This concept effectively reduces the current load of each amplifier by $1/N$, where N is the number of amplifiers. For further details on the design and performance of this circuit, see the [Reference Design for Implementation of the Load Sharing Concept for Large-Signal Applications](#).

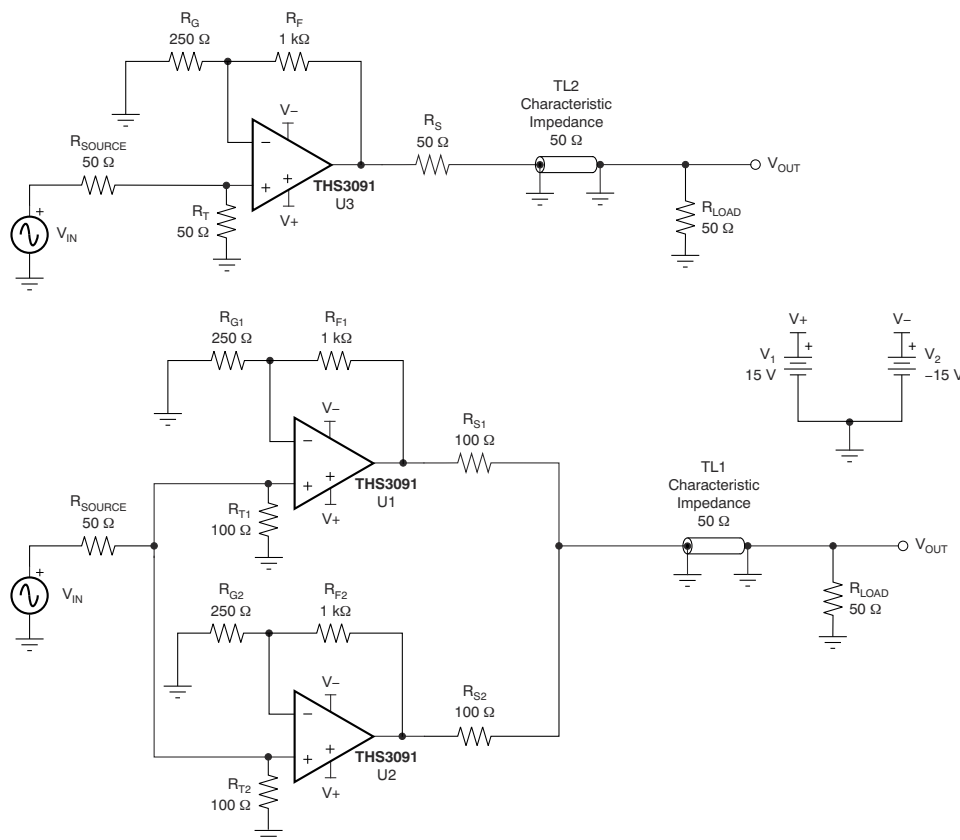

Figure 9-1. Reference THS3091 and THS3091 Load Sharing Test Configurations

9.2.1 Design Requirements

Use two THS3091 amplifiers in a parallel load-sharing circuit to improve distortion performance.

Table 9-1. Design Parameters

DESIGN PARAMETER	VALUE
V_{OPP}	20 V
R_{LOAD}	100 Ω

9.2.2 Detailed Design Procedure

In addition to providing higher output current drive to the load, the load sharing configuration can also provide improved distortion performance. In many cases, an operational amplifier shows better distortion performance as the load current decreases (that is, for higher resistive loads) until the feedback resistor starts to dominate the current load. In a load sharing configuration of N amplifiers in parallel, the equivalent current load that each amplifier drives is 1/N times the total load current.

As shown in [Figure 9-1](#) for example, in a two-amplifier load sharing configuration with matching resistance driving a resistive load (RL), each series resistance is $2 \times RL$ and each amplifier drives $2 \times RL$. A convenient indicator of whether an op amp will function well in a load sharing configuration is the characteristic performance graph of harmonic distortion versus load resistance. [Figure 7-9](#) and [Figure 7-10](#) show more information. Such graphs can be found in most of TI's high-speed amplifier data sheets. These graphs can be used to obtain a general sense of whether or not an amplifier will show improved distortion performance in load sharing configurations.

[Figure 9-1](#) shows two test circuits: one for a single THS3091 amplifier driving a double-terminated (50-Ω cable), and one with two THS3091 amplifiers in a load sharing configuration. In the load sharing configuration, the two 100-Ω series output resistors act in parallel to provide 50-Ω back-matching to the 50-Ω cable.

[Figure 9-2](#) and [Figure 9-3](#) show the 32-MHz, 18-VPP sine wave output amplitudes for the single THS3091 configuration and the load sharing configuration, respectively, measured using an oscilloscope. An ideal sine wave is also included as a visual reference (the dashed red line). [Figure 9-2](#) shows visible distortion in the single THS3091 output. In the load sharing configuration of [Figure 9-3](#), however, no obvious degradation is visible.

[Figure 9-4](#) and [Figure 9-5](#) show the 64-MHz sine wave outputs of the two configurations from [Figure 9-1](#). While the single THS3091 output is clearly distorted in [Figure 9-4](#), the output of the load sharing configuration in [Figure 9-5](#) shows only minor deviations from the ideal sine wave.

9.2.3 Application Curves

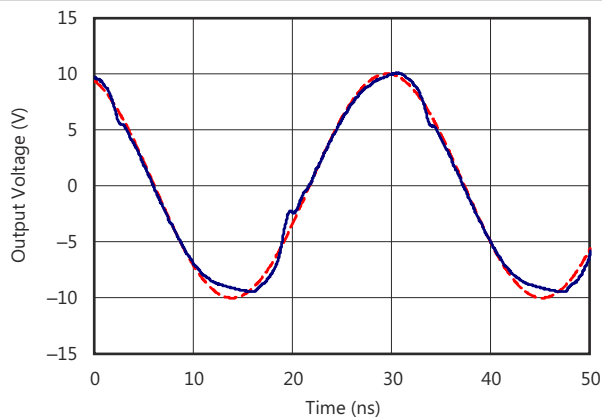

Figure 9-2. 32-MHz Sine Wave Output (Gain = 5 V/V, Signal Amplitude Referred to Amplifier Output), Single THS3091 Circuit Configuration

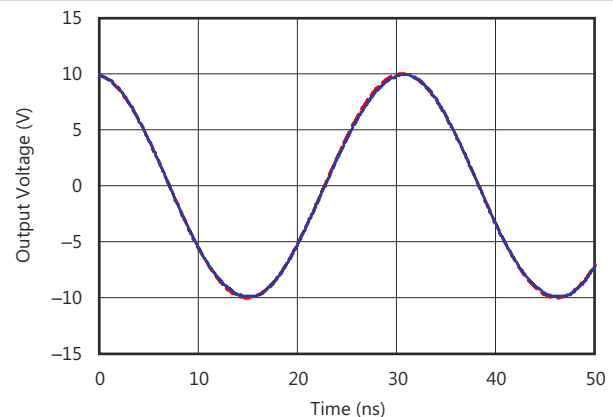

Figure 9-3. 32-MHz Sine Wave Output (Gain = 5 V/V, Signal Amplitude Referred to Amplifier Output), Two THS3091 Amplifiers in Load Sharing Configuration

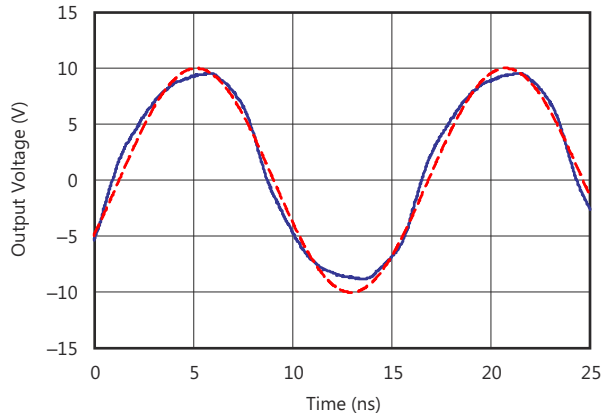

Figure 9-4. 64-MHz Sine Wave Output (Gain = 5 V/V, Signal Amplitude Referred to Amplifier Output), Single THS3091 Circuit Configuration

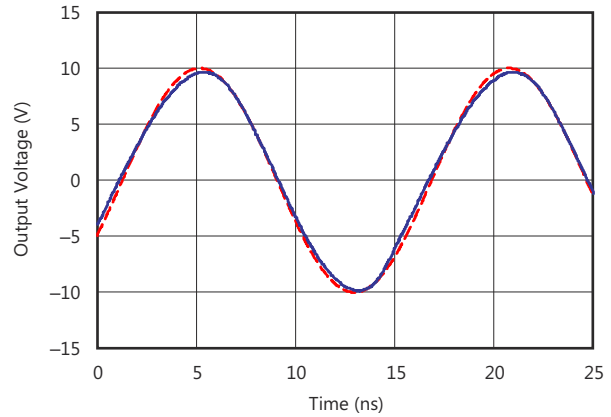

Figure 9-5. 64-MHz Sine Wave Output (Gain = 5 V/V, Signal Amplitude Referred to Amplifier Output), Two THS3091 Amplifiers in Load Sharing Configuration

9.3 Power Supply Recommendations

The THS3091 operates using a single or dual supply as long as the input CM voltage range (CMIR) has the required headroom to either supply rail. Operating from a single supply has numerous advantages. With the negative supply at ground, the dc errors due to the $-PSRR$ term are minimized. Decouple the supplies with low-inductance, ceramic capacitors to ground less than 0.5 inches from the device pins. The use of a ground plane is recommended; as in most high-speed devices, remove the ground plane near device sensitive pins such as the inputs. For split-supply operation, an optional supply decoupling capacitor across the two power supplies improves second harmonic distortion performance.

9.4 Layout

9.4.1 Layout Guidelines

To optimize performance with a high-frequency amplifier, such as the THS309x, pay careful attention to board layout parasitic and external component types.

Recommendations to optimize performance include the following:

- Minimize parasitic capacitance to any ac ground for all of the signal I/O pins. Parasitic capacitance on the output and input pins can cause instability. To reduce unwanted capacitance, open a window around the signal I/O pins in all of the ground and power planes around those pins. Otherwise, keep ground and power planes unbroken elsewhere on the board.
- Minimize the distance [< 0.25 inch (6.35 mm)] from the power supply pins to the high-frequency 0.1- μF and 100-pF decoupling capacitors. At the device pins, keep the ground and power plane layout away from the signal I/O pins. Avoid narrow power and ground traces to minimize inductance between the pins and the decoupling capacitors. Always decouple the power-supply connections with these capacitors. Use larger (6.8 μF or more) tantalum decoupling capacitors, effective at lower frequency, on the main supply pins. The decoupling capacitors can be placed somewhat farther from the device, and can be shared among several devices in the same area of the printed circuit board (PCB).
- Connections to other wideband devices on the board can be made with short direct traces or through onboard transmission lines. For short connections, consider the trace and the input to the next device as a lumped capacitive load. Use relatively wide traces [0.05 inch (1.3 mm) to 0.1 inch (2.54 mm)], preferably with ground and power planes opened up around the traces. Estimate the total capacitive load and determine if isolation resistors on the outputs are necessary. Low-parasitic capacitive loads (< 4 pF) may not need an R_{ISO} because the THS309x are nominally compensated to operate with a 2-pF parasitic load. Higher parasitic capacitive loads without an R_{ISO} are allowed as the signal gain increases (increasing the unloaded phase margin).

9.4.1.1 PowerPAD Design Considerations

The THS309x are available in a thermally-enhanced PowerPAD family of packages. These packages are constructed using a downset leadframe on which the die is mounted [see [Figure 9-6\(a\)](#) and [Figure 9-6\(b\)](#)]. This arrangement results in the lead frame being exposed as a thermal pad on the underside of the package [see [Figure 9-6\(c\)](#)]. Because this thermal pad has direct thermal contact with the die, excellent thermal performance can be achieved by providing a good thermal path away from the thermal pad. Note that devices such as the THS309x have no electrical connection between the PowerPAD and the die.

The PowerPAD package allows for both assembly and thermal management in one manufacturing operation. During the surface-mount solder operation (when the leads are being soldered), the thermal pad can also be soldered to a copper area underneath the package. Through the use of thermal paths within this copper area, heat can be conducted away from the package into either a ground plane or other heat-dissipating device.

The PowerPAD package represents a breakthrough in combining the small area and ease of assembly of surface mount with the awkward mechanical methods of heatsinking.

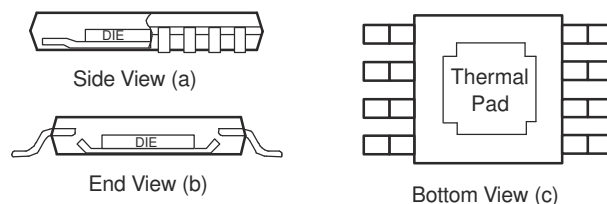

Figure 9-6. Views of Thermal Enhanced Package

Although there are many ways to properly heatsink the PowerPAD package, the following section lists the recommended steps.

9.4.1.1.1 PowerPAD Layout Considerations

1. [Figure 9-7](#) shows a PCB with a top-side etch pattern. Place an etch for the leads as well as etch for the thermal pad.
2. Place 13 holes in the area of the thermal pad. The recommended holes size is 0.01 inch (0.254 mm) in diameter. Keep the holes small so that solder wicking through the holes is not a problem during reflow.
3. Additional vias can be placed anywhere along the thermal plane outside of the thermal pad area. These additional vias help dissipate the heat generated by the THS309x device. The additional vias can be larger than the 0.01-inch (0.254 mm) diameter vias directly under the thermal pad. The additional vias can be larger because these vias are not in the thermal pad area to be soldered so that wicking is not a problem.
4. Connect all holes to the internal ground plane. The PowerPAD is electrically isolated from the silicon and all leads. Therefore, connecting the PowerPAD to any potential voltage, such as V_{S-} , is acceptable because there is no electrical connection to the silicon.
5. When connecting these holes to the ground plane, do not use the typical web or spoke via connection methodology. Web connections have a high thermal resistance that is useful for slowing the heat transfer during soldering operations. This high thermal resistance makes the soldering of vias that have plane connections easier. In this application, however, low thermal resistance is desired for the most efficient heat transfer. Therefore, connect the holes under the THS309x PowerPAD package connection to the internal ground plane with a complete connection around the entire circumference of the plated-through hole.
6. On the top-side solder mask, leave the terminals of the package and the thermal pad area with the 13 holes exposed. On the bottom-side solder mask, cover the 13 holes of the thermal pad area. This guideline prevents solder from being pulled away from the thermal pad area during the reflow process.
7. Apply solder paste to the exposed thermal pad area and all of the device pins.
8. With these preparatory steps in place, the device is simply placed in position and run through the solder reflow operation as with any standard surface-mount component. This process results in a device that is properly installed.

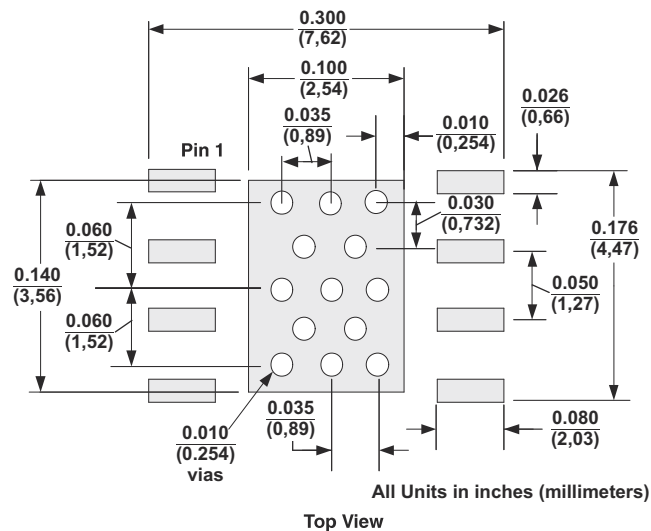

Figure 9-7. DDA PowerPAD PCB Etch and Via Pattern

9.4.1.2 Power Dissipation and Thermal Considerations

The THS309x incorporates automatic thermal shutoff protection. This protection circuitry shuts down the amplifier if the junction temperature exceeds approximately 160°C. When the junction temperature reduces to approximately 140°C, the amplifier turns on again. But, for maximum performance and reliability, the designer must ensure that the design does not exceed a junction temperature of 125°C. Between 125°C and 150°C, damage does not occur, but the performance of the amplifier begins to degrade and long-term reliability suffers. The thermal characteristics of the device are dictated by the package and the PCB. Maximum power dissipation for a given package is calculated using the following equation:

$$P_{Dmax} = \frac{T_{max} - T_A}{\theta_{JA}} \quad (6)$$

Where:

- P_{Dmax} is the maximum power dissipation in the amplifier (W).
- T_{max} is the absolute maximum junction temperature (°C)
- T_A is the ambient temperature (°C)
- $\theta_{JA} = \theta_{JC} + \theta_{CA}$
- θ_{JC} is the thermal coefficient from the silicon junctions to the case (°C/W)
- θ_{CA} is the thermal coefficient from the case to ambient air (°C/W)

For systems where heat dissipation is more critical, the THS3091 and THS3095 are offered in an 8-pin SOIC (DDA) with PowerPAD package. The thermal coefficient for the PowerPAD packages are substantially improved over the traditional SOIC. The data for the PowerPAD packages assume a board layout that follows the PowerPAD layout guidelines referenced above and detailed in the [PowerPAD™ Thermally Enhanced Package application note](#). If the PowerPAD is not soldered to the PCB, then the thermal impedance increases substantially, which can cause serious heat and performance issues. Be sure to always solder the PowerPAD to the PCB to optimize performance.

When determining whether or not the device satisfies the maximum power-dissipation requirement, consider not only quiescent power dissipation, but also dynamic power dissipation. Often times, dynamic power dissipation is difficult to quantify because the signal pattern is inconsistent, but an estimate of the RMS power dissipation can provide visibility into a possible problem.

9.4.2 Layout Example

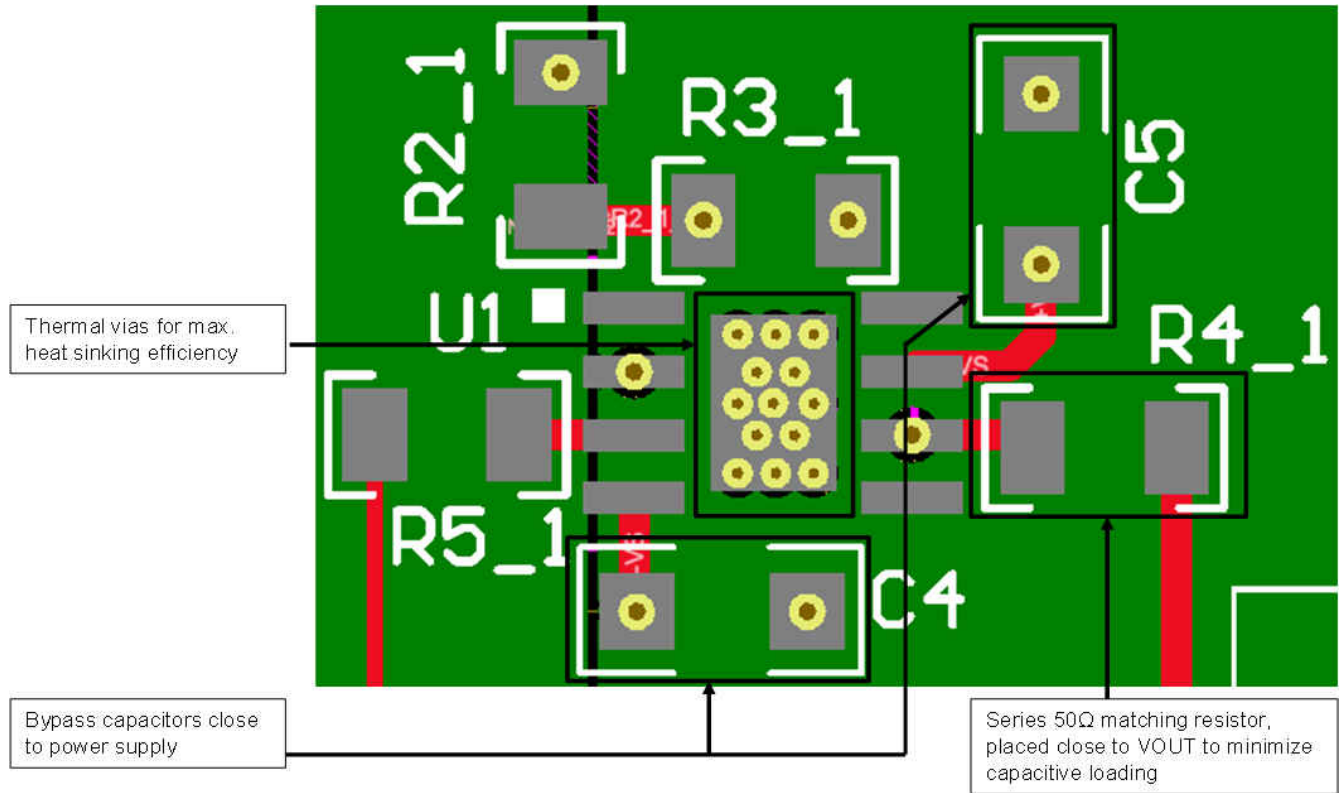

Figure 9-8. Layout Recommendation

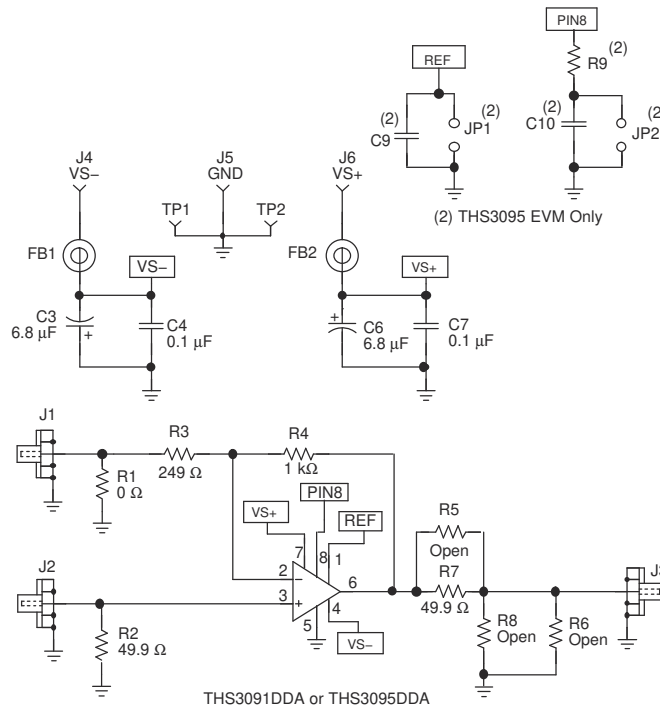

Figure 9-9. THS3091 EVM Circuit Configuration

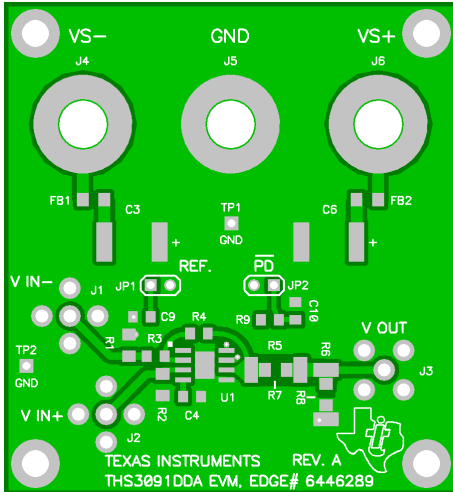

Figure 9-10. THS3091 EVM Board Layout (Top Layer)

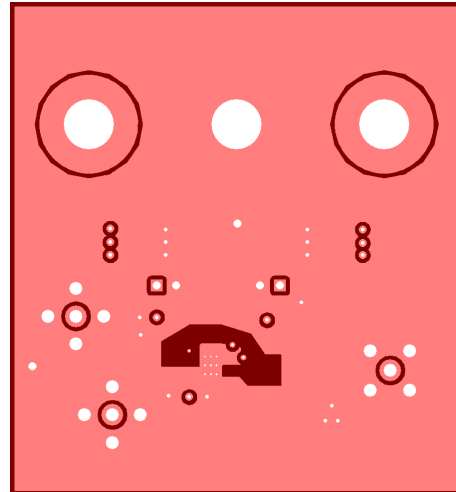

Figure 9-11. THS3091 EVM Board Layout (Second and Third Layers)

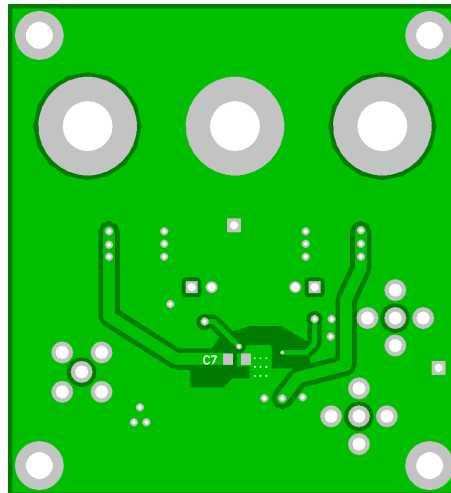

Figure 9-12. THS3091 EVM Board Layout (Bottom Layer)

10 Device and Documentation Support

10.1 Device Support

10.1.1 Development Support

- [TIDA-00684: High-Bandwidth Arbitrary Waveform Generator Reference Design: DC or AC coupled, High-Voltage output](#)
- [TIDA-00075: Wide-Bandwidth and High-Voltage Arbitrary Waveform Generator Front End](#)
- [TIDA-00023: Reference Design for Implementation of the Load Sharing Concept for Large-Signal Applications](#)

10.2 Documentation Support

10.2.1 Related Documentation

For related documentation, see the following:

- Texas Instruments, [PowerPAD™ Made Easy application brief](#)
- Texas Instruments, [PowerPAD™ Thermally Enhanced Package technical brief](#)
- Texas Instruments, [Voltage Feedback vs Current Feedback Amplifiers application note](#)
- Texas Instruments, [Current Feedback Analysis and Compensation application note](#)
- Texas Instruments, [Current Feedback Amplifiers: Review, Stability, and Application application note](#)
- Texas Instruments, [Effect of Parasitic Capacitance in Op Amp Circuits application note](#)
- Texas Instruments, [Expanding the Usability of Current-Feedback Amplifiers analog journal](#)

10.3 Receiving Notification of Documentation Updates

To receive notification of documentation updates, navigate to the device product folder on ti.com. Click on *Subscribe to updates* to register and receive a weekly digest of any product information that has changed. For change details, review the revision history included in any revised document.

10.4 Support Resources

[TI E2E™ support forums](#) are an engineer's go-to source for fast, verified answers and design help — straight from the experts. Search existing answers or ask your own question to get the quick design help you need.

Linked content is provided "AS IS" by the respective contributors. They do not constitute TI specifications and do not necessarily reflect TI's views; see TI's [Terms of Use](#).

10.5 Trademarks

PowerPAD™ and TI E2E™ are trademarks of Texas Instruments.
All trademarks are the property of their respective owners.

10.6 Electrostatic Discharge Caution



This integrated circuit can be damaged by ESD. Texas Instruments recommends that all integrated circuits be handled with appropriate precautions. Failure to observe proper handling and installation procedures can cause damage.

ESD damage can range from subtle performance degradation to complete device failure. Precision integrated circuits may be more susceptible to damage because very small parametric changes could cause the device not to meet its published specifications.

10.7 Glossary

[TI Glossary](#) This glossary lists and explains terms, acronyms, and definitions.

11 Mechanical, Packaging, and Orderable Information

The following pages include mechanical, packaging, and orderable information. This information is the most current data available for the designated devices. This data is subject to change without notice and revision of this document. For browser-based versions of this data sheet, refer to the left-hand navigation.

PACKAGING INFORMATION

Orderable Device	Status (1)	Package Type	Package Drawing	Pins	Package Qty	Eco Plan (2)	Lead finish/ Ball material (6)	MSL Peak Temp (3)	Op Temp (°C)	Device Marking (4/5)	Samples
THS3091D	LIFEBUY	SOIC	D	8	75	RoHS & Green	NIPDAU	Level-1-260C-UNLIM	-40 to 85	3091	
THS3091DDA	ACTIVE	SO PowerPAD	DDA	8	75	RoHS & Green	SN	Level-1-260C-UNLIM	-40 to 85	3091	Samples
THS3091DDAG3	ACTIVE	SO PowerPAD	DDA	8	75	RoHS & Green	SN	Level-1-260C-UNLIM	-40 to 85	3091	Samples
THS3091DDAR	ACTIVE	SO PowerPAD	DDA	8	2500	RoHS & Green	SN	Level-1-260C-UNLIM	-40 to 85	3091	Samples
THS3091DDARG3	LIFEBUY	SO PowerPAD	DDA	8	2500	RoHS & Green	SN	Level-1-260C-UNLIM	-40 to 85	3091	
THS3091DR	LIFEBUY	SOIC	D	8	2500	RoHS & Green	NIPDAU	Level-1-260C-UNLIM	-40 to 85	3091	
THS3091IDGNR	ACTIVE	HVSSOP	DGN	8	2500	RoHS & Green	NIPDAU	Level-2-260C-1 YEAR	-40 to 85	3091	Samples
THS3095D	LIFEBUY	SOIC	D	8	75	RoHS & Green	NIPDAU	Level-1-260C-UNLIM	-40 to 85	3095	
THS3095DDA	ACTIVE	SO PowerPAD	DDA	8	75	RoHS & Green	SN	Level-1-260C-UNLIM	-40 to 85	3095	Samples
THS3095DDAR	ACTIVE	SO PowerPAD	DDA	8	2500	RoHS & Green	SN	Level-1-260C-UNLIM	-40 to 85	3095	Samples
XTHS3091IDGNR	ACTIVE	HVSSOP	DGN	8	2500	TBD	Call TI	Call TI	-40 to 85		Samples

(1) The marketing status values are defined as follows:

ACTIVE: Product device recommended for new designs.

LIFEBUY: TI has announced that the device will be discontinued, and a lifetime-buy period is in effect.

NRND: Not recommended for new designs. Device is in production to support existing customers, but TI does not recommend using this part in a new design.

PREVIEW: Device has been announced but is not in production. Samples may or may not be available.

OBSELETE: TI has discontinued the production of the device.

(2) **RoHS:** TI defines "RoHS" to mean semiconductor products that are compliant with the current EU RoHS requirements for all 10 RoHS substances, including the requirement that RoHS substance do not exceed 0.1% by weight in homogeneous materials. Where designed to be soldered at high temperatures, "RoHS" products are suitable for use in specified lead-free processes. TI may reference these types of products as "Pb-Free".

RoHS Exempt: TI defines "RoHS Exempt" to mean products that contain lead but are compliant with EU RoHS pursuant to a specific EU RoHS exemption.

Green: TI defines "Green" to mean the content of Chlorine (Cl) and Bromine (Br) based flame retardants meet JS709B low halogen requirements of <=1000ppm threshold. Antimony trioxide based flame retardants must also meet the <=1000ppm threshold requirement.

(3) MSL, Peak Temp. - The Moisture Sensitivity Level rating according to the JEDEC industry standard classifications, and peak solder temperature.

(4) There may be additional marking, which relates to the logo, the lot trace code information, or the environmental category on the device.

⁽⁵⁾ Multiple Device Markings will be inside parentheses. Only one Device Marking contained in parentheses and separated by a "~" will appear on a device. If a line is indented then it is a continuation of the previous line and the two combined represent the entire Device Marking for that device.

⁽⁶⁾ Lead finish/Ball material - Orderable Devices may have multiple material finish options. Finish options are separated by a vertical ruled line. Lead finish/Ball material values may wrap to two lines if the finish value exceeds the maximum column width.

Important Information and Disclaimer:The information provided on this page represents TI's knowledge and belief as of the date that it is provided. TI bases its knowledge and belief on information provided by third parties, and makes no representation or warranty as to the accuracy of such information. Efforts are underway to better integrate information from third parties. TI has taken and continues to take reasonable steps to provide representative and accurate information but may not have conducted destructive testing or chemical analysis on incoming materials and chemicals. TI and TI suppliers consider certain information to be proprietary, and thus CAS numbers and other limited information may not be available for release.

In no event shall TI's liability arising out of such information exceed the total purchase price of the TI part(s) at issue in this document sold by TI to Customer on an annual basis.

TAPE AND REEL INFORMATION

QUADRANT ASSIGNMENTS FOR PIN 1 ORIENTATION IN TAPE

*All dimensions are nominal

Device	Package Type	Package Drawing	Pins	SPQ	Reel Diameter (mm)	Reel Width W1 (mm)	A0 (mm)	B0 (mm)	K0 (mm)	P1 (mm)	W (mm)	Pin1 Quadrant
THS3091DDAR	SO PowerPAD	DDA	8	2500	330.0	12.4	6.4	5.2	2.1	8.0	12.0	Q1
THS3091DR	SOIC	D	8	2500	330.0	12.4	6.4	5.2	2.1	8.0	12.0	Q1
THS3091IDGNR	HVSSOP	DGN	8	2500	330.0	12.4	5.3	3.4	1.4	8.0	12.0	Q1
THS3095DDAR	SO PowerPAD	DDA	8	2500	330.0	12.4	6.4	5.2	2.1	8.0	12.0	Q1

TAPE AND REEL BOX DIMENSIONS

*All dimensions are nominal

Device	Package Type	Package Drawing	Pins	SPQ	Length (mm)	Width (mm)	Height (mm)
THS3091DDAR	SO PowerPAD	DDA	8	2500	350.0	350.0	43.0
THS3091DR	SOIC	D	8	2500	350.0	350.0	43.0
THS3091DGNR	HVSSOP	DGN	8	2500	356.0	356.0	35.0
THS3095DDAR	SO PowerPAD	DDA	8	2500	350.0	350.0	43.0

TUBE

*All dimensions are nominal

Device	Package Name	Package Type	Pins	SPQ	L (mm)	W (mm)	T (μm)	B (mm)
THS3091D	D	SOIC	8	75	505.46	6.76	3810	4
THS3091DDA	DDA	HSOIC	8	75	505.46	6.76	3810	4
THS3091DDAG3	DDA	HSOIC	8	75	505.46	6.76	3810	4
THS3095D	D	SOIC	8	75	505.46	6.76	3810	4
THS3095DDA	DDA	HSOIC	8	75	505.46	6.76	3810	4

GENERIC PACKAGE VIEW

DGN 8

PowerPAD VSSOP - 1.1 mm max height

3 x 3, 0.65 mm pitch

SMALL OUTLINE PACKAGE

This image is a representation of the package family, actual package may vary.
Refer to the product data sheet for package details.



4225482/A

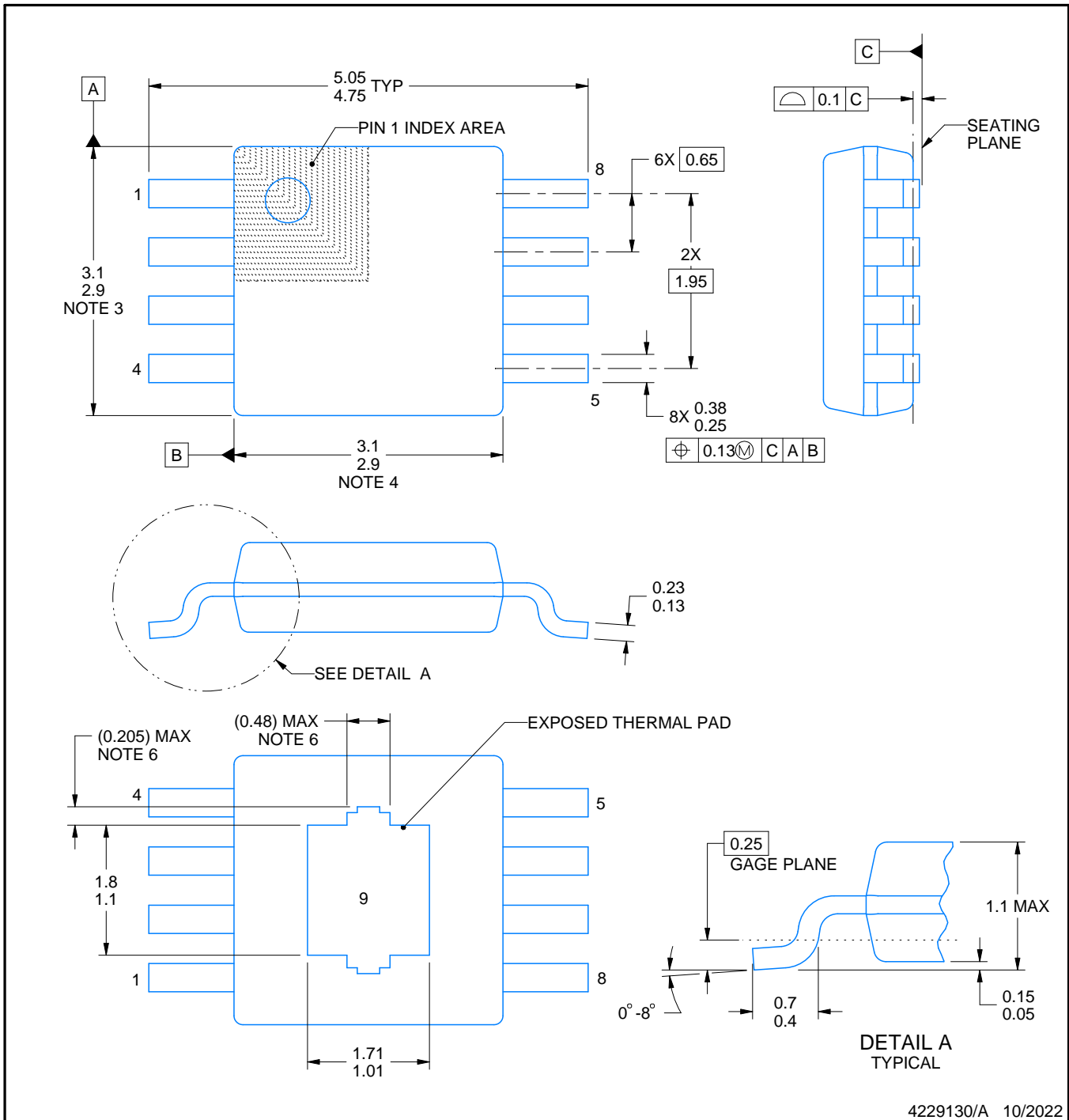

4229130/A 10/2022

NOTES:

PowerPAD is a trademark of Texas Instruments.

1. All linear dimensions are in millimeters. Any dimensions in parenthesis are for reference only. Dimensioning and tolerancing per ASME Y14.5M.
2. This drawing is subject to change without notice.
3. This dimension does not include mold flash, protrusions, or gate burrs. Mold flash, protrusions, or gate burrs shall not exceed 0.15 mm per side.
4. This dimension does not include interlead flash. Interlead flash shall not exceed 0.25 mm per side.
5. Reference JEDEC registration MO-187.
6. Features may differ or may not be present.

EXAMPLE BOARD LAYOUT

DGN0008H

PowerPAD™ VSSOP - 1.1 mm max height

SMALL OUTLINE PACKAGE

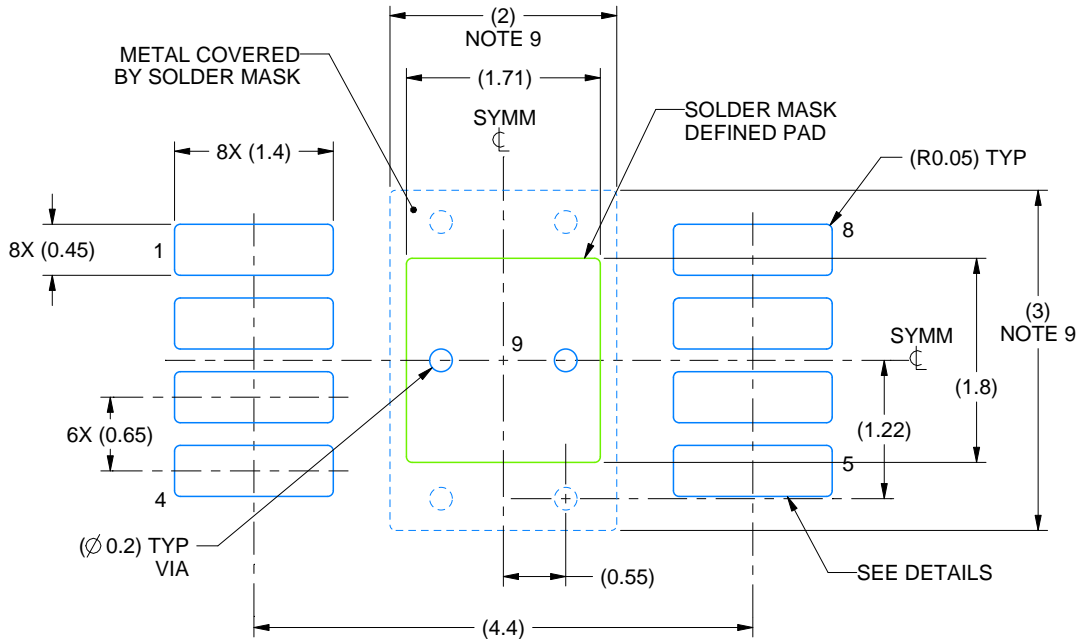

LAND PATTERN EXAMPLE
EXPOSED METAL SHOWN
SCALE: 15X

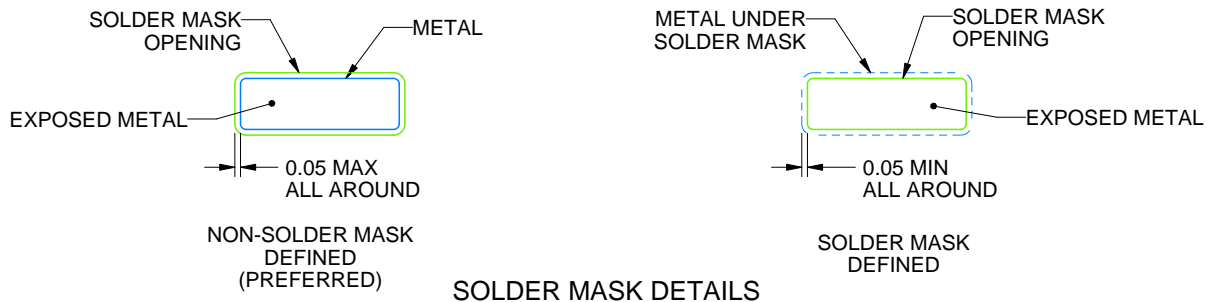

SOLDER MASK DETAILS

4229130/A 10/2022

NOTES: (continued)

7. Publication IPC-7351 may have alternate designs.
8. Solder mask tolerances between and around signal pads can vary based on board fabrication site.
9. Vias are optional depending on application, refer to device data sheet. If any vias are implemented, refer to their locations shown on this view. It is recommended that vias under paste be filled, plugged or tented.
10. Size of metal pad may vary due to creepage requirement.

EXAMPLE STENCIL DESIGN

DGN0008H

PowerPAD™ VSSOP - 1.1 mm max height

SMALL OUTLINE PACKAGE

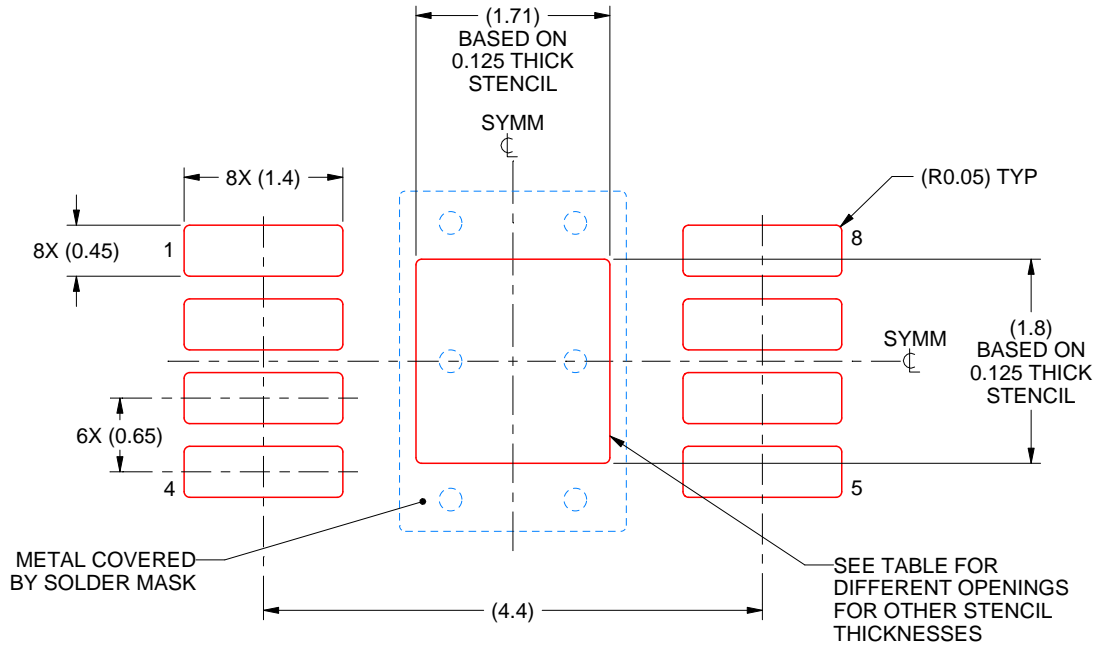

SOLDER PASTE EXAMPLE
EXPOSED PAD 9:
100% PRINTED SOLDER COVERAGE BY AREA
SCALE: 15X

STENCIL THICKNESS	SOLDER STENCIL OPENING
0.1	1.91 X 2.01
0.125	1.71 X 1.80 (SHOWN)
0.15	1.56 X 1.64
0.175	1.45 X 1.52

4229130/A 10/2022

NOTES: (continued)

11. Laser cutting apertures with trapezoidal walls and rounded corners may offer better paste release. IPC-7525 may have alternate design recommendations.
12. Board assembly site may have different recommendations for stencil design.



Images above are just a representation of the package family, actual package may vary.
Refer to the product data sheet for package details.

DDA0008D



PACKAGE OUTLINE

PowerPAD™ SOIC - 1.7 mm max height

PLASTIC SMALL OUTLINE

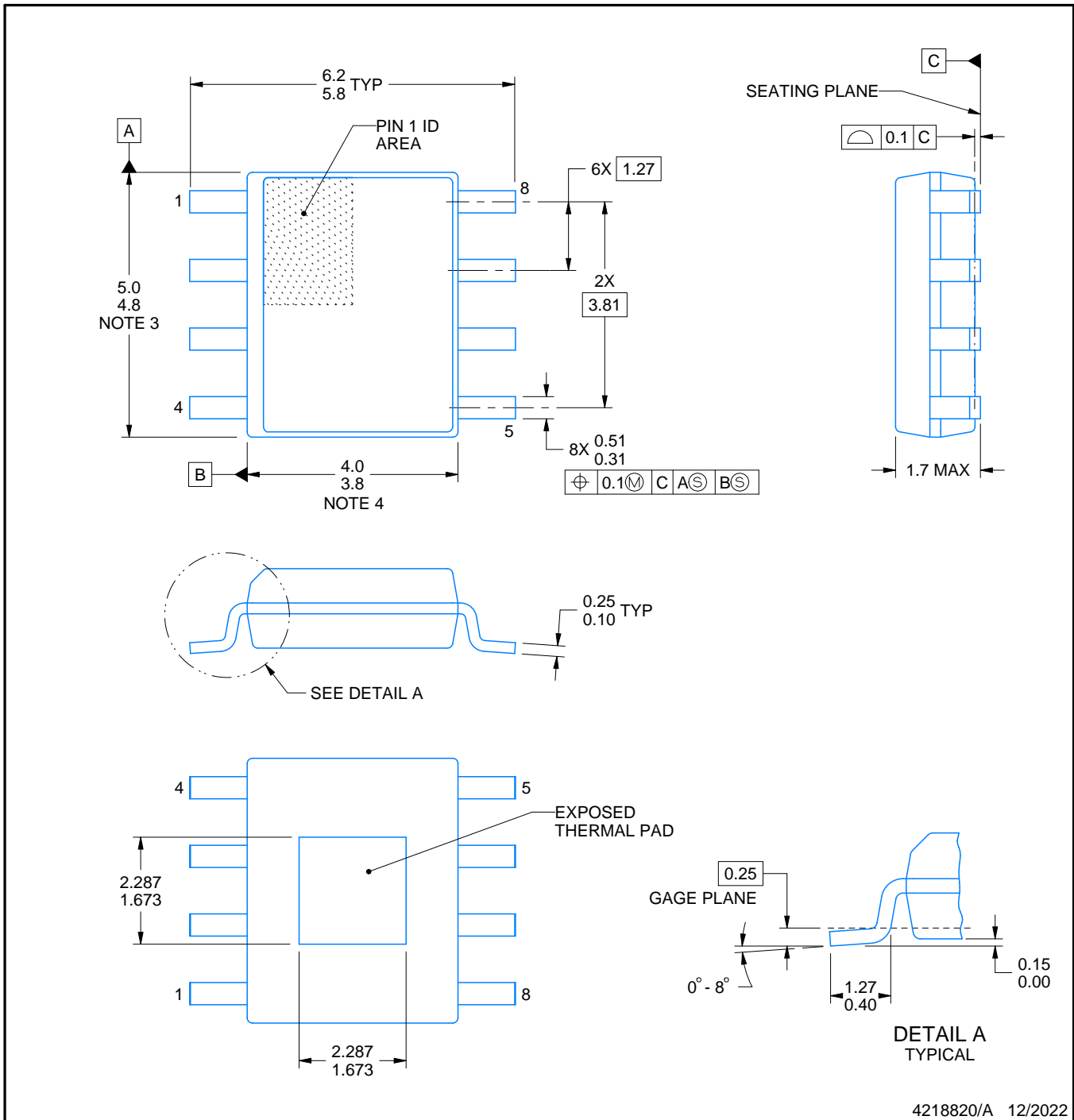

4218820/A 12/2022

PowerPAD is a trademark of Texas Instruments.

NOTES:

1. All linear dimensions are in millimeters. Any dimensions in parenthesis are for reference only. Dimensioning and tolerancing per ASME Y14.5M.
2. This drawing is subject to change without notice.
3. This dimension does not include mold flash, protrusions, or gate burrs. Mold flash, protrusions, or gate burrs shall not exceed 0.15 mm per side.
4. This dimension does not include interlead flash. Interlead flash shall not exceed 0.25 mm per side.
5. Reference JEDEC registration MS-012, variation BA.

EXAMPLE BOARD LAYOUT

DDA0008D

PowerPAD™ SOIC - 1.7 mm max height

PLASTIC SMALL OUTLINE

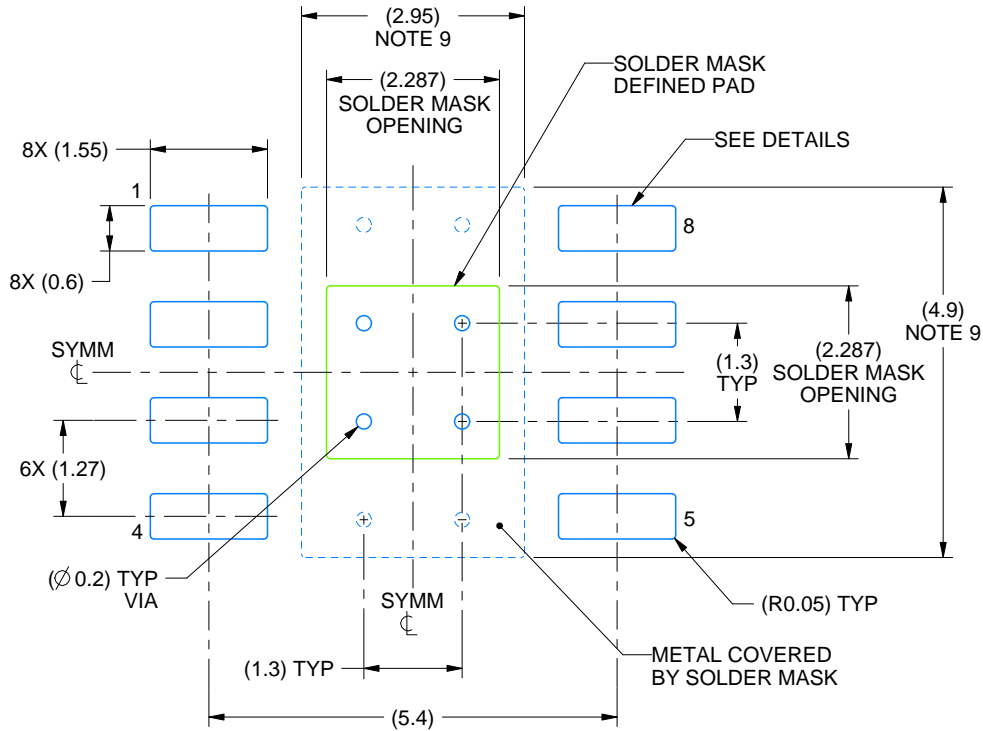

LAND PATTERN EXAMPLE
SCALE:10X

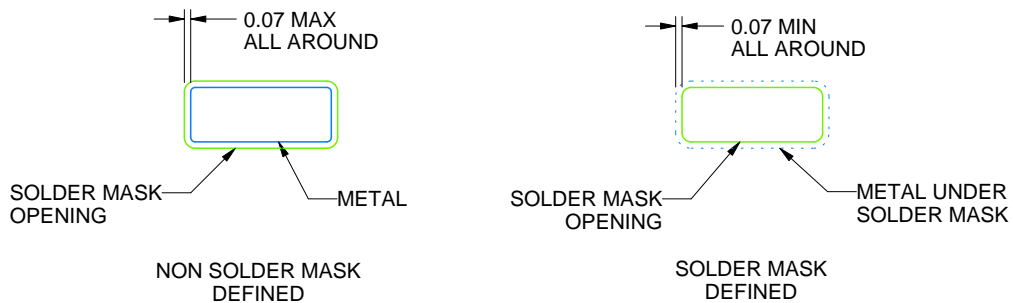

SOLDER MASK DETAILS

4218820/A 12/2022

NOTES: (continued)

- 6. Publication IPC-7351 may have alternate designs.
- 7. Solder mask tolerances between and around signal pads can vary based on board fabrication site.
- 8. This package is designed to be soldered to a thermal pad on the board. For more information, see Texas Instruments literature numbers SLMA002 (www.ti.com/lit/slma002) and SLMA004 (www.ti.com/lit/slma004).
- 9. Size of metal pad may vary due to creepage requirement.

EXAMPLE STENCIL DESIGN

DDA0008D

PowerPAD™ SOIC - 1.7 mm max height

PLASTIC SMALL OUTLINE

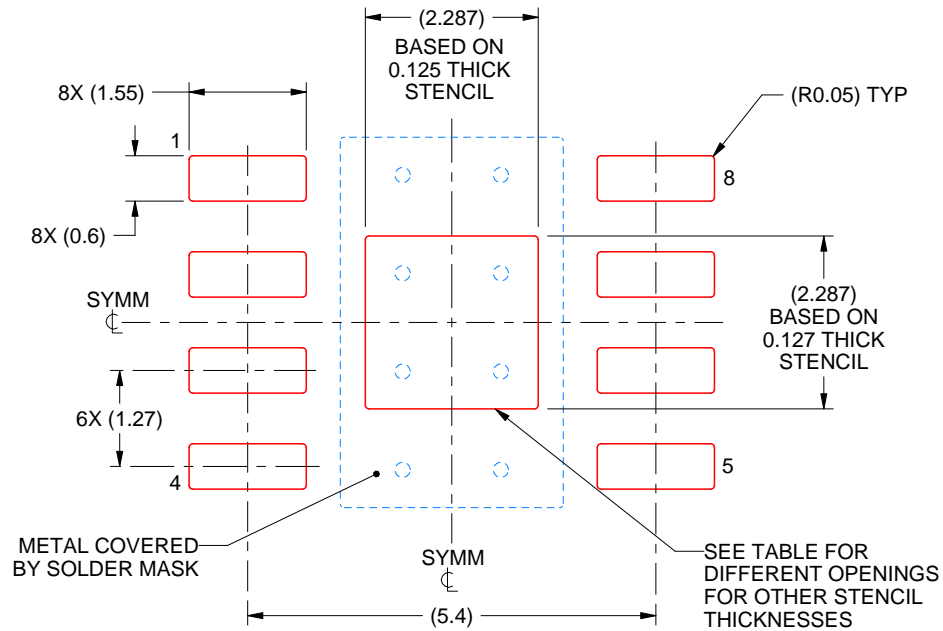

SOLDER PASTE EXAMPLE
EXPOSED PAD
100% PRINTED SOLDER COVERAGE BY AREA
SCALE:10X

STENCIL THICKNESS	SOLDER STENCIL OPENING
0.1	2.557 X 2.557
0.125	2.287 X 2.287 (SHOWN)
0.150	2.088 X 2.088
0.175	1.933 X 1.933

4218820/A 12/2022

NOTES: (continued)

10. Laser cutting apertures with trapezoidal walls and rounded corners may offer better paste release. IPC-7525 may have alternate design recommendations.
11. Board assembly site may have different recommendations for stencil design.



D0008A

PACKAGE OUTLINE

SOIC - 1.75 mm max height

SMALL OUTLINE INTEGRATED CIRCUIT



4214825/C 02/2019

NOTES:

- Linear dimensions are in inches [millimeters]. Dimensions in parenthesis are for reference only. Controlling dimensions are in inches. Dimensioning and tolerancing per ASME Y14.5M.
- This drawing is subject to change without notice.
- This dimension does not include mold flash, protrusions, or gate burrs. Mold flash, protrusions, or gate burrs shall not exceed $.006$ [0.15] per side.
- This dimension does not include interlead flash.
- Reference JEDEC registration MS-012, variation AA.

EXAMPLE BOARD LAYOUT

D0008A

SOIC - 1.75 mm max height

SMALL OUTLINE INTEGRATED CIRCUIT



LAND PATTERN EXAMPLE
 EXPOSED METAL SHOWN
 SCALE:8X



SOLDER MASK DETAILS

4214825/C 02/2019

NOTES: (continued)

- 6. Publication IPC-7351 may have alternate designs.
- 7. Solder mask tolerances between and around signal pads can vary based on board fabrication site.

EXAMPLE STENCIL DESIGN

D0008A

SOIC - 1.75 mm max height

SMALL OUTLINE INTEGRATED CIRCUIT



SOLDER PASTE EXAMPLE
BASED ON .005 INCH [0.125 MM] THICK STENCIL
SCALE:8X

4214825/C 02/2019

NOTES: (continued)

8. Laser cutting apertures with trapezoidal walls and rounded corners may offer better paste release. IPC-7525 may have alternate design recommendations.
9. Board assembly site may have different recommendations for stencil design.

IMPORTANT NOTICE AND DISCLAIMER

TI PROVIDES TECHNICAL AND RELIABILITY DATA (INCLUDING DATA SHEETS), DESIGN RESOURCES (INCLUDING REFERENCE DESIGNS), APPLICATION OR OTHER DESIGN ADVICE, WEB TOOLS, SAFETY INFORMATION, AND OTHER RESOURCES "AS IS" AND WITH ALL FAULTS, AND DISCLAIMS ALL WARRANTIES, EXPRESS AND IMPLIED, INCLUDING WITHOUT LIMITATION ANY IMPLIED WARRANTIES OF MERCHANTABILITY, FITNESS FOR A PARTICULAR PURPOSE OR NON-INFRINGEMENT OF THIRD PARTY INTELLECTUAL PROPERTY RIGHTS.

These resources are intended for skilled developers designing with TI products. You are solely responsible for (1) selecting the appropriate TI products for your application, (2) designing, validating and testing your application, and (3) ensuring your application meets applicable standards, and any other safety, security, regulatory or other requirements.

These resources are subject to change without notice. TI grants you permission to use these resources only for development of an application that uses the TI products described in the resource. Other reproduction and display of these resources is prohibited. No license is granted to any other TI intellectual property right or to any third party intellectual property right. TI disclaims responsibility for, and you will fully indemnify TI and its representatives against, any claims, damages, costs, losses, and liabilities arising out of your use of these resources.

TI's products are provided subject to [TI's Terms of Sale](#) or other applicable terms available either on [ti.com](https://www.ti.com) or provided in conjunction with such TI products. TI's provision of these resources does not expand or otherwise alter TI's applicable warranties or warranty disclaimers for TI products.

TI objects to and rejects any additional or different terms you may have proposed.

Mailing Address: Texas Instruments, Post Office Box 655303, Dallas, Texas 75265
Copyright © 2023, Texas Instruments Incorporated